

LINEAR ACTUATORS

Rolaram

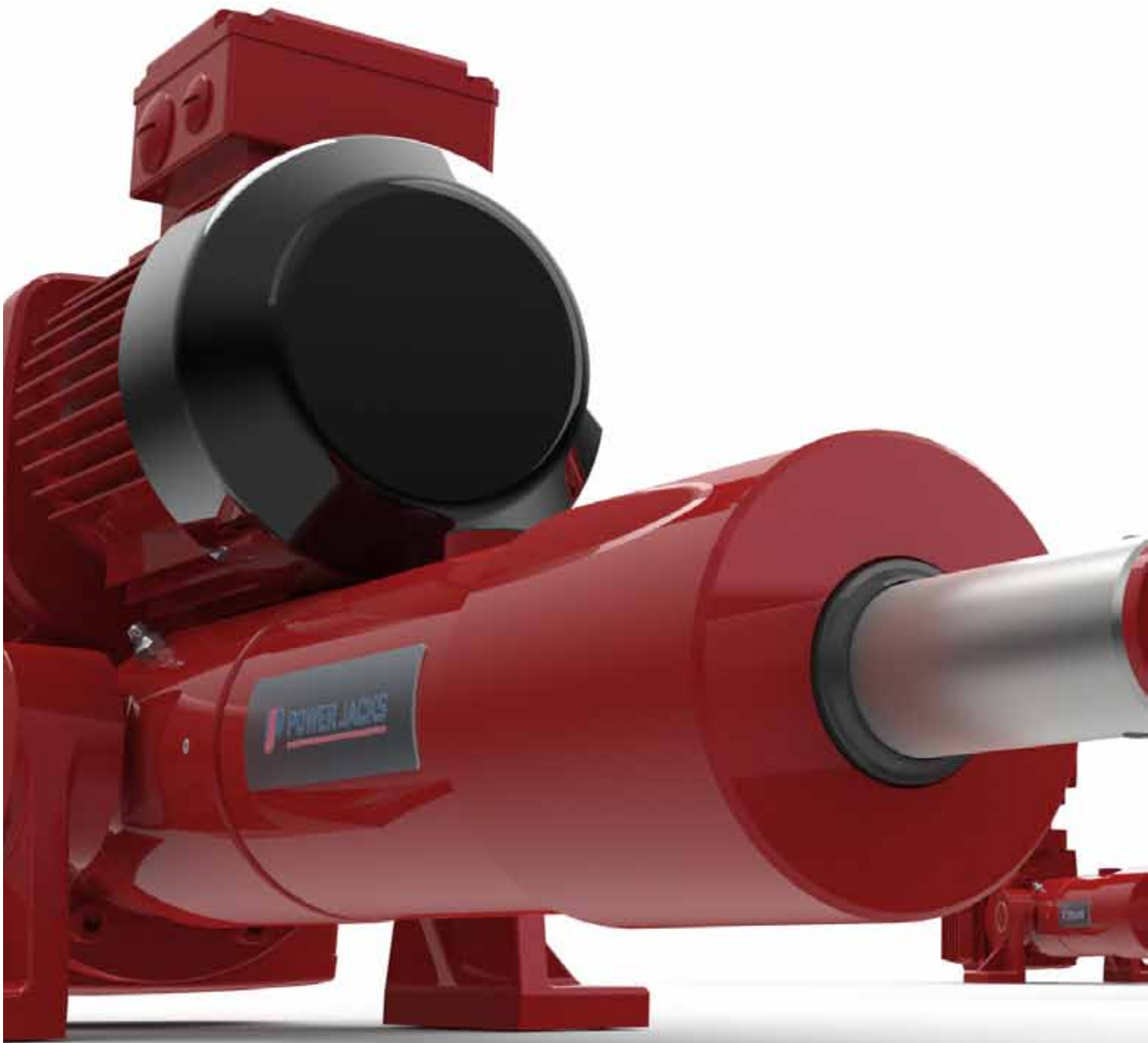



Contents

Linear Actuators (Electro-Mechanical)

1	Overview of Rolaram® Linear Actuator Range.....	4
2	Working Applications for Rolaram® Actuators.....	6
3	Product Code for Rolaram® Actuators.....	7
4	Rolaram® Linear Actuator Range.....	8
5	How to Select a Rolaram® Actuator.....	10
6	Rolaram® Performance Data.....	11
7	Rolaram® Linear Actuator Dimensions.....	17
8	Rolaram® Accessories and Options.....	21
9	Special Rolaram® Designs and Applications.....	22

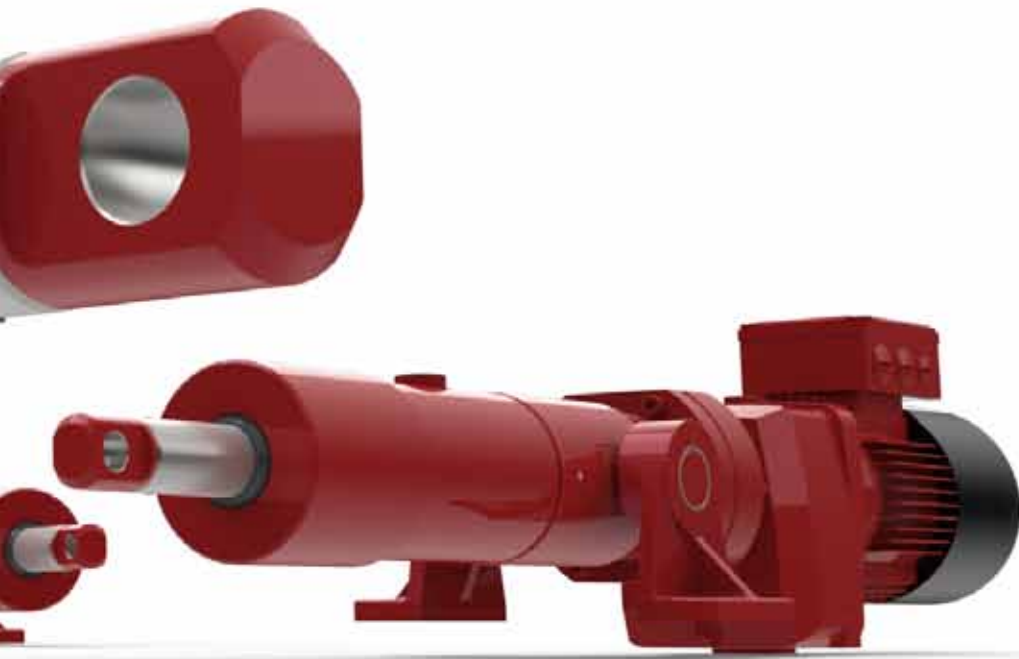

1. Overview of Rolaram® Linear Actuator Range

What is a Rolaram® Linear Actuator?

Rolaram® is an electro-mechanical linear actuator, which consists of either a Spiracon™ planetary roller screw or a ball screw, driven by an electric motor, through a reduction gearbox. The lead screw converts rotary motion to linear movement. As the screw rotates, the nut extends and retracts the ram, which is attached to the load.

Parallel Configuration

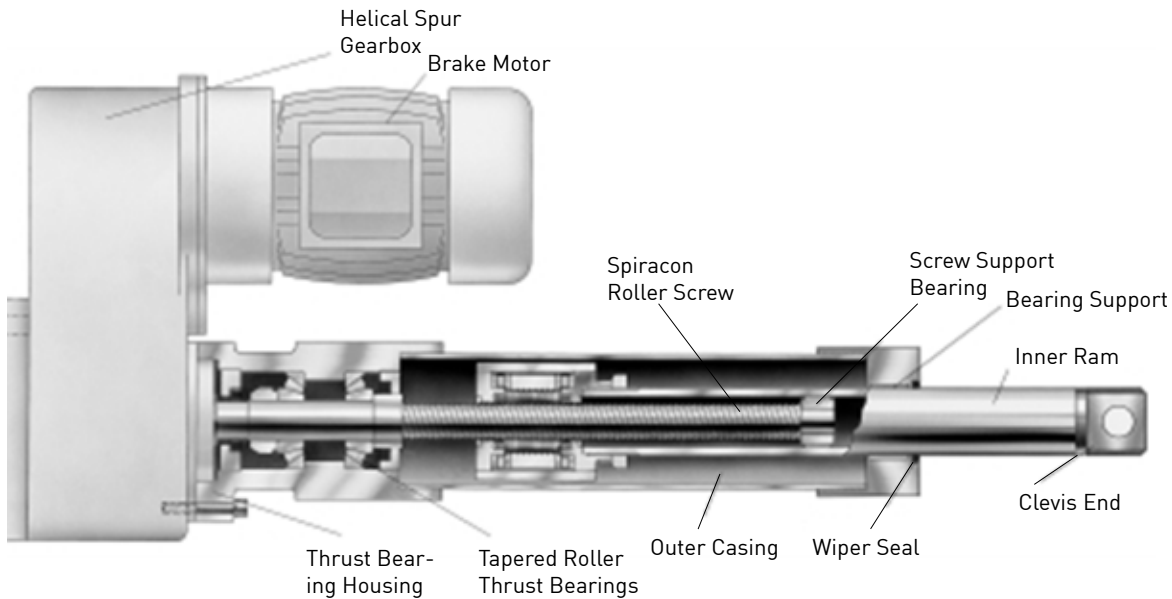

The Spiracon™ Roller Screw

This unique patented system consists of a multi-start screw with an involute thread form and a number of planetary rollers with annular grooves, which engage with the screw. These rollers also engage with a grooved load bearing element, which transmits the load through roller thrust bearings, to the nut housing. The rolling action results in a high efficiency mechanism, while the line contact and hardened and ground construction achieves a high dynamic load carrying capacity, along with almost no axial backlash or wear.

Spiracon Nut

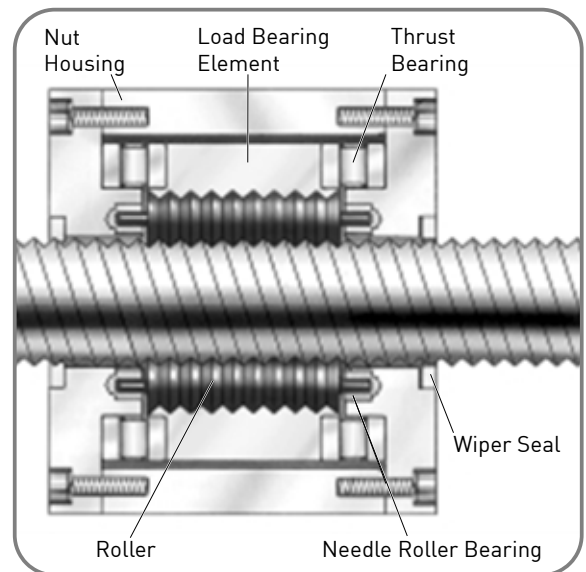

Main features of Rolaram® Actuators

- High efficiency screw mechanism and gearbox
- High dynamic load capacity and wide speed range
- Controllable for synchronisation
- Precise repeatability of positioning
- Long life and low maintenance and running costs
- Clean operation and low noise
- Cost effective package
- Guided ram option

Advantages over other Actuators

Rolaram actuators can not only match the load capacity of hydraulic cylinders and exceed the load capacity of conventional electro-mechanical actuators but also provide:

- Easy installation, no pipework, powerpack and valves
- Easy synchronisation of more than one unit
- Accurate and repeatable positioning using simplified system
- Low power consumption and running costs
- No oil leaks, contamination or fire risk
- Low noise system
- Higher dynamic capacity, higher speed capability and longer life

Applications for Rolaram® Actuators

Rolaram actuators are well proven throughout the world in a wide variety of industries including

Nuclear Food Processing Aerospace Paper

Metal Processing Offshore and Marine Medical Communications Automotive Defence Typical applications include:

Scissor lifts, lifting platforms, robotics, continuous paint pumps, medical beds, coiling/decoiling machines, tundish cars, continuous operation process lines.

Drive Configurations

Right Angle



Parallel



In-Line

2. Working Applications for Rolaram® Actuators



Application

Die splitter for opening up 20 tonne die sets, prior to their use in the production of car body panels.

Linear Actuation Requirements

Dies require to be split evenly, with all corners being moved simultaneously, within 5 microns of each other.

Solution

4 identical Rolaram actuators mounted one on each corner of the die splitter. Each driven by a servo motor, controlled by a PLC, to ensure synchronisation of all 4 actuators, within the required limits of positional accuracy. Cranes were previously used to split the dies and the die splitter now represents a considerable time saving in preparing dies for production.

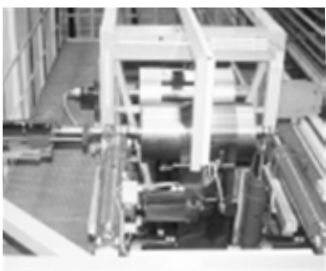

Application

European Community funded research project, to monitor the steering roll characteristics on a zincplating line for steel strip. The aim is to optimise downtime and repairs on the line.

Linear Actuation Requirements

5 axis control of the steering roll (X, Y, Z and tilt), to a repeatable positional accuracy of less than 10 microns.

Solution

5 Rolaram actuators, each driven by an AC synchronous servo motor, controlled by a Programmable Multi Axis Control System. The units are fitted with an incremental encoder, a load cell and backlash free gimble mounting.

Operating

Moving a maximum load of 270kg at a maximum acceleration of 1 metre/second² and a maximum speed of Characteristics 0.5 metre/second, to a repeatable accuracy of less than 10 microns.



Application

Grinding head adjustment to put precise tapers on camshaft cam lobes.

Linear Actuation Requirements

Moving a load of 270kg, on a continuous duty cycle, over an operating life of 10 years.

Solution

A single Rolaram actuator fitted with an AC servo motor and encoder. Unit is sealed to prevent the ingress of abrasive dust.



Application

De-chocking car for removal and refitting of 14 tonne bearing assemblies (chocks) on steel rolls.

Linear Actuation Requirements

4 stage sequence of operation

- Locate car on its rails, parallel to and exactly on centre line of bearing assembly.
- High speed traverse drive to place lift platform under bearing assembly.
- Raise lift platform to sense load of 14 tonne bearing assembly, then move 75 microns to locate centrally around tapered shaft of steel roll.
- Drive platform traverse to clear bearing assembly from shaft (slow speed) then safely locate bearing assembly on car (high speed). A hydraulic solution was unable to satisfy the above requirements.

Solution

A total of 2 Rolaram actuators and 6 Spiracon roller screws, to provide a combination of high speed (up to 45 metres/minute), very slow speed and micron accuracy. Since the de-chocking car has been installed, the time required to prepare rolls for changing at the mill stands has been reduced by up to 50%.

3. Product Code for Rolaram® Actuators

The product code is of the following form:

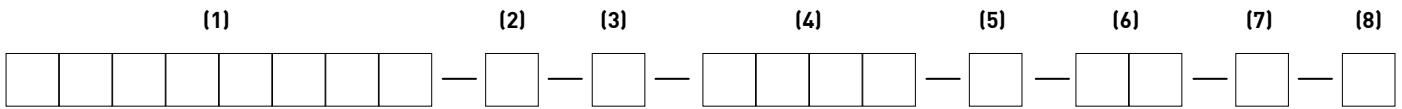

(1) Product Code

An 8 digit code obtained from Technical Charts (refer 2.2.6.)

(2) Drive Configuration

R - Right Angle
P - Parallel
H - In-Line

(3) Unguided/guided

P - Unguided Ram
K - Guided Ram

(4) Stroke

A 4 figure code to represent the required stroke in mm.

(5) End Fitting

C - Clevis End
T - Top Plate
S - Screwed End

(6) Mounting

RC - Rear Clevis
TN - Trunnion without Feet
TF - Trunnion with Trunnion Feet
TE - Trunnion with Trunnion Feet and End Cap Foot

(7) Proximity Switches

P - With stroke detecting Proximity Switches
0 - Without stroke detecting Proximity Switches

(8) Encoder

E - With Encoder
0 - Without Encoder

Example Part Number

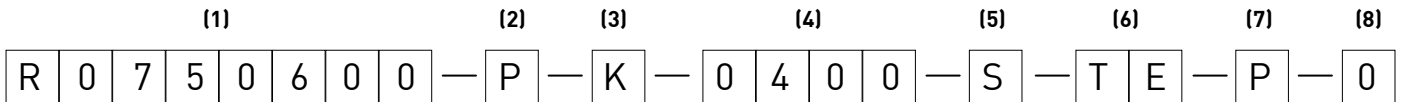

(1) Model R075 Actuator with linear speed of 600 mm/min

(2) Parallel Drive Configuration

(3) Guided Ram

(4) Stroke of 400 mm

(5) Screwed End Fitting

(6) Trunnion Mounting with Trunnion Feet and End Cap Foot

(7) With Proximity Switches

(8) Without Encoder

Notes: (1) The above part number defines a standard catalogue unit. Where a standard unit does not meet the customer's requirement, Power Jacks will be pleased to design a special unit.

4. Rolaram® Linear Actuator Range

There are 8 standard Rolaram models, available in 2 standard drive configurations, each with 10 linear speeds and offering a wide range of load capabilities. The R050, R075, R100 and R125 models are available in a Ball Screw version, for applications where positional accuracy is less important and a more cost effective solution is desired.

Where the standard range does not meet the application specification, special actuators can be designed to meet customers' specific requirements (refer page 9).

Dynamic Load Capacity and Linear Speed

Dynamic load capacity from 4 kN to 400 kN (0.4 to 40 tonnes). A wide choice of linear speeds is available, from less than 250 mm/ minute to 7000 mm/minute. The speed range is achieved by using a combination of gearbox ratios, screw leads and standard motor speeds. The load/speed curves below illustrate by model how the dynamic load capacity varies with linear speed.

Load/Speed Curves

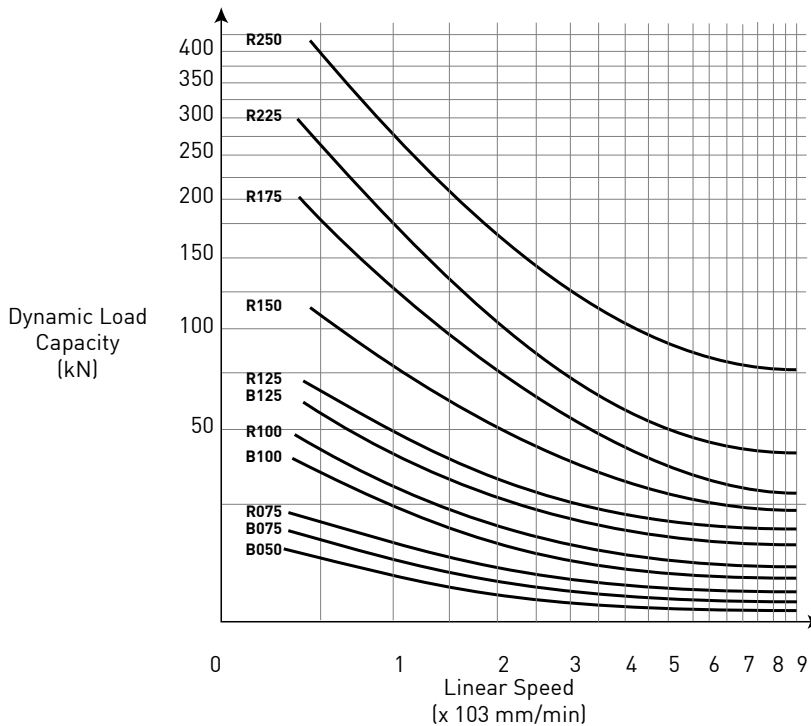

Drive

The drive is a standard 415v 3ph AC brake motor, mounted either at right angles or parallel to the actuator ram. The motor is fitted with a brake as standard, to insure that despite the high efficiency screw and gear system, the actuator is self sustaining and will not back drive. High efficiency helical spur and spiral bevel gearing are used to achieve the choice of reduction ratios and the option of a right angle or parallel drive.

Stroke

Each model can be provided with a stroke length up to the maximum shown in the Technical Charts. Please note that these strokes allow for the maximum dynamic load in compression. For a tensile load, greater maximum strokes can be accommodated depending on the linear speed. Where the stroke required exceeds the maximum shown, or there is a high static load, please contact our Technical Sales Department.

Standard Features

- Right angle or parallel drive configurations
- Choice of end fittings - clevis, screwed end, top plate
- Trunnion mounting (with or without feet)
- Rear Clevis
- Proximity switches, encoder
- Ball screw version for R075, R100 and R125 models
- Guided ram

Operating Life and Duty

The actuator models listed in the Technical Charts are capable of very high operating lives (in excess of 10,000 hours for some high speed models). The ball screw version may have a lower life expectancy than the equivalent roller screw version. Due to the almost limitless number of possible configurations, please consult our Technical Sales Department for an estimate of life for individual applications. Continuous duty applications e.g. reciprocating pumping systems can also be realised.

Efficiency

The inherent high efficiency of the screw and helical spur and spiral bevel gear system combine to give an overall mechanical efficiency of typically 80%. Power consumption is therefore minimised and a compact actuator is assured.

Synchronisation

Synchronisation of two or more Rolaram actuators can be achieved in one of two ways, depending on the requirements of the application:

- Using encoders, synchronous motors or servo systems (i.e. each unit motorised)
- By linking the units mechanically with drive shafting, driven by one common motor

Positional Accuracy

The inherent accuracy of the roller screw and low backlash gearing provide repeatable positioning to within 0.005mm (5 microns), when the actuator is combined with a suitable drive and control system. Ball screw models have a positional accuracy of 50 microns.

Guiding the Load

Side loads on the actuator ram should be avoided by ensuring that the load is guided. The load guide mechanism should resist the torque developed at the ram by the screw mechanism, thus precluding the use of spherical end fittings. The guided ram option, which utilises rolling element followers, eliminates the need for torsional restraint and therefore allows flexibility in the choice of end fittings.

Mounting Position

The Rolaram actuator can be mounted for operation in any orientation.

Safety Features

- In the event of power failure, the fail-safe brake on the motor will maintain the position of the actuator
- Totally enclosed and sealed unit
- Built in proximity switches/limit switches
- Guided ram version



Operating Environment

All units are constructed and finished to suit industrial operating conditions. The actuator is sealed at the ram and including the standard brake motor is protected to IP55 enclosure. Normal operating temperatures are from -10°C to +50°C. However, Power Jacks products have been proven in very low operating temperatures (-30°C- Arctic) and in very high temperatures (+70°C- steelworks). Please contact our Technical Sales Department to discuss hostile or hazardous operating environments.

Lubrication and Maintenance

Rolaram actuators require only a minimum of maintenance during the normal operating life. Depending upon the duty, periodic lubrication should be carried out on the Spiracon roller nut, thrust housing and helical spur/spiral bevel gearbox, according to the application and our recommended maintenance instructions.

Specials

The Rolaram concept has been successfully applied in many varied "special" applications, requiring for example:

- Very high linear speed (over 50 metres/minute) or acceleration (over 3 metres/sec²)
- Very high dynamic load (over 1000kN)
- In-line drive configuration
- Special drive e.g. inverter, servo, DC, stepper
- Temperature extremes or hazardous environment (e.g. subsea)
- Built in load cell
- Special mounting or restricted space
- Very low noise (under 60dB)

5. How to Select a Rolaram® Actuator

There are 4 simple steps as follows :

Step 1

Using the load/speed curves on page 8, select the actuator model which has an adequate dynamic load capacity for the required linear speed. Positional accuracy and life considerations may dictate selection of the roller screw version for models R075, R100 and R125.

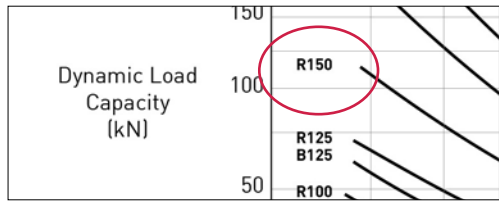

Step 2

Referring to the Technical Charts (page 11) for that model, select the nearest linear speed for the chosen right angle or parallel drive configuration.

Ball Screw		
Product Code	Linear Speed (mm/min)	Dynamic Load Capacity (kN)
B0500260	260	13
B0500440	440	11
B0500550	550	10
B0500700	700	9.5
B0501080	1080	8
B0501560	1560	7
B0502150	2150	6.5

Step 3

Check the required stroke is within the maximum stroke limit.

Actuator	Frame Size	Max Stroke (mm) in Compression ☺	Basic Weight (kg)
	63	835	4.2
	63	930	4.6
	63	990	4.8
	80	1025	4.9
	80	1140	5.2

Step 4

Choose the end fitting, mounting arrangement and other options required to complete the full product code shown on page 7.

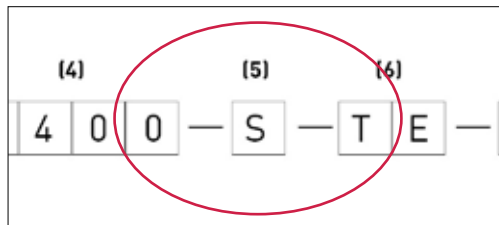

Example

Dynamic Load = 50 kN (in compression)
 Linear Speed = 900 mm/minute Stroke= 1500 mm
 Parallel drive configuration, unguided ram, fitted with a clevis end, trunnion mounting (without feet) and proximity switches.

Step 1

Using load/speed curves on page 8, select model R125.

Step 2

Referring to Technical Chart for Model R125-Parallel Configuration on page 11, select product code R1251040.

Step 3

The required stroke of 1500 mm is less than the maximum shown (1600 mm).

Step 4

The complete product code is therefore **R1251040-P-P-1500-C-TN-P-0**

6. Rolaram® Performance Data

General Rolaram Performance Summary

Load	Up to 400 kN (40 Te)	
Linear Speed	Up to 7000 mm/min	
Stroke	Up to 5000 mm	
Efficiency	80% (typical)	
Accuracy	Roller Screw	Up to within 0.005 mm (5 micron)
	Ball Screw	Up to within 0.05 mm (50 micron)
Operating Temperature	Normal	-10o C → +50o C
	Extreme (consult Power Jacks)	-30o C → +70o C
Life	10 000 hours typical as standard at full rated load and speed	
Enclosure	IP55	

Model B050/R050

Parallel Configuration

Ball Screw

Product Code	Linear Speed (mm/min)	Dynamic Load capacity (kN) ①	Motor		Max Stroke (mm) in Compression ②	Basic Weight (kg) ③
			Power (kW)	Frame Size		
B0500260	260	13	0.18	63	835	46
B0500440	440	11	0.25	63	930	46.5
B0500550	550	10	0.37	63	990	47
B0500700	700	9.5	0.37	80	1025	47
B0501080	1080	8	0.55	80	1140	50
B0501560	1560	7	0.75	80	1250	50
B0502150	2150	6.5	0.75	80	1300	50
B0502750	2750	6	0.75	80	1365	50
B0503600	3600	5.5	1.1	80	1435	55
B0505550	5550	4.5	1.1	80	1620	55

Roller Screw

Product Code	Linear Speed (mm/min)	Dynamic Load capacity (kN) ①	Motor		Max Stroke (mm) in Compression ②	Basic Weight (kg) ③
			Power (kW)	Frame Size		
On Application						

- Notes
1. Static load capacity = 19kN
 2. For tensile loads, greater maximum strokes can be accommodated, depending on linear speed.
 3. Total weight = basic weight + 2.2 kg (ball screw) per 100 mm stroke.
 4. All weights are approximate.

Model B075/R075

Right Angle Configuration

	Product Code	Linear Speed (mm/min)	Dynamic Load capacity (kN) ①	Motor		Max Stroke (mm) in Compression ②	Basic Weight (kg) ③
				Power (kW)	Frame Size		
BALL SCREW	B0750280 ④	280	21.0	0.18	80	2200	22.5
	B0750720 ④	720	16.0	0.25	71	2500	22.5
	B0750970 ④	970	12.0	0.25	71	2900	22.5
	B0751270	1270	9.0	0.25	71	3200	22.5
	B0751470	1470	7.8	0.25	71	3500	22.5
	B0751650	1650	7.0	0.37	71	4000	22.5
	B0752560	2560	6.6	0.37	71	4000	22.5
	B0754030	4030	6.2	0.55	71	3400	22.5
	B0754700	4700	5.3	0.55	71	3100	22.5
B0757130	7130	4.8	0.75	80	2500	36.5	

	Product Code	Linear Speed (mm/min)	Dynamic Load capacity (kN) ①	Motor		Max Stroke (mm) in Compression ②	Basic Weight (kg) ③
				Power (kW)	Frame Size		
ROLLER SCREW	R0750240 ④	240	23.0	0.12	71	400	22.5
	R0750620 ④	620	19.0	0.25	71	450	22.5
	R0750840 ④	840	14.0	0.25	71	530	22.5
	R0751010	1010	11.5	0.25	71	600	22.5
	R0751280	1280	9.0	0.25	71	690	22.5
	R0751850	1850	9.3	0.37	71	690	22.5
	R0752400	2400	7.2	0.37	71	750	22.5
	R0754290	4290	6.0	0.55	71	750	22.5
	R0754800	4800	5.4	0.55	71	800	22.5
R0757000	7000	5.0	0.75	80	800	36.5	

Notes: ① Static load capacity = 36KN

Model B075/R075

Parallel Configuration

	Product Code	Linear Speed (mm/min)	Dynamic Load capacity (kN) ①	Motor		Max Stroke (mm) in Compression ②	Basic Weight (kg) ③
				Power (kW)	Frame Size		
BALL SCREW	B0750280	250	22.0	0.12	63	2200	29.0
	B0750720	670	17.0	0.25	71	2500	29.0
	B0750970	1340	12.7	0.37	71	2900	30.0
	B0751270	1600	10.5	0.37	71	3200	30.0
	B0751470	1960	8.6	0.37	71	3500	30.0
	B0751650	2670	6.4	0.37	71	4100	30.0
	B0752560	3200	5.3	0.37	71	3800	30.0
	B0754030	5400	4.7	0.55	71	2900	30.0
	B0754700	6080	4.1	0.55	71	2700	30.0
B0757130	6770	3.1	0.75	71	2600	30.0	

	Product Code	Linear Speed (mm/min)	Dynamic Load capacity (kN) ①	Motor		Max Stroke (mm) in Compression ②	Basic Weight (kg) ③
				Power (kW)	Frame Size		
ROLLER SCREW	R0750240	220	24.0	0.12	63	400	29.0
	R0750620	600	19.0	0.25	63	450	29.0
	R0750840	1020	17.0	0.37	71	480	30.0
	R0751010	1220	14.3	0.37	71	530	30.0
	R0751280	1570	11.2	0.37	71	600	30.0
	R0751850	2040	8.5	0.37	71	690	30.0
	R0752400	2610	6.7	0.37	71	770	30.0
	R0754290	4070	6.5	0.55	71	780	30.0
	R0754800	5930	4.4	0.55	71	940	30.0
R0757000	7120	3.7	0.75	71	1000	30.0	

Notes: ① Static load capacity = 36kN

② For tensile loads, greater maximum strokes can be accommodated, depending on the linear speed

③ Total weight = Basic weight + 2.4 kg (ball screw) or 1.0 kg (roller screw) per 100 mm stroke. All weights are approximate

④ Dimension AB applies (motor axis offset)

Model B100/R100

Right Angle Configuration

	Product Code	Linear Speed [mm/min]	Dynamic Load capacity [kN] ①	Motor		Max Stroke [mm] in Compression ②	Basic Weight [kg] ③
				Power [kW]	Frame Size		
BALL SCREW	B1000280 ④	280	41.5	0.25	80	2400	40.0
	B1000350 ④	350	33.0	0.25	80	2700	40.0
	B1000970 ④	970	26.0	0.55	80	3000	40.0
	B1001280	1280	19.5	0.55	80	3500	40.0
	B1001660	1660	15.0	0.55	80	4000	40.0
	B1002380	2380	14.4	0.75	80	4100	40.0
	B1002590	2590	13.2	0.75	80	4200	40.0
	B1004100	4100	12.2	1.1	80	3700	40.0
	B1004780	4780	10.5	1.1	80	3400	40.0
B1007180	7180	9.6	1.5	90	2800	45.0	

	Product Code	Linear Speed [mm/min]	Dynamic Load capacity [kN] ①	Motor		Max Stroke [mm] in Compression ②	Basic Weight [kg] ③
				Power [kW]	Frame Size		
ROLLER SCREW	R1000240 ④	240	48.0	0.25	80	850	40.0
	R1000300 ④	300	38.0	0.25	80	900	40.0
	R1000840 ④	840	30.5	0.55	80	1100	40.0
	R1001010	1010	25.5	0.55	80	1200	40.0
	R1001280	1280	20.0	0.55	80	1400	40.0
	R1001840	1840	19.0	0.75	80	1400	40.0
	R1002380	2380	14.8	0.75	80	1500	40.0
	R1004410	4410	11.7	1.1	80	1750	40.0
	R1004920	4920	10.4	1.1	80	1800	40.0
R1007080	7080	9.9	1.5	90	1800	49.0	

Notes: ① Static load capacity = 75kN

Model B100/R100

Parallel Configuration

	Product Code	Linear Speed [mm/min]	Dynamic Load capacity [kN] ①	Motor		Max Stroke [mm] in Compression ②	Basic Weight [kg] ③
				Power [kW]	Frame Size		
BALL SCREW	B1000270	270	42.0	0.25	71	2400	47.0
	B1000530	530	32.0	0.37	71	2700	47.0
	B1000930	930	27.0	0.55	80	3000	47.0
	B1001260	1260	20.0	0.55	80	3500	47.0
	B1001680	1680	15.0	0.55	80	4000	47.0
	B1002090	2090	12.0	0.55	80	4500	47.0
	B1003060	3060	11.2	0.75	80	4200	50.0
	B1004290	4290	8.0	0.75	80	3600	50.0
	B1006770	6770	7.4	1.1	80	2800	50.0
B1007580	7580	6.6	1.1	80	2700	50.0	

	Product Code	Linear Speed [mm/min]	Dynamic Load capacity [kN] ①	Motor		Max Stroke [mm] in Compression ②	Basic Weight [kg] ③
				Power [kW]	Frame Size		
ROLLER SCREW	R1000360	360	50.0	0.37	71	800	47.0
	R1000490	490	35.5	0.37	71	900	47.0
	R1000930	930	28.0	0.55	71	1100	47.0
	R1001140	1140	23.0	0.55	71	1200	47.0
	R1001510	1510	16.4	0.55	71	1400	47.0
	R1001900	1900	13.7	0.55	71	1500	47.0
	R1002880	2880	13.0	0.75	80	1600	50.0
	R1003900	3900	9.1	0.75	80	1800	50.0
	R1006430	6430	8.1	1.1	80	1800	50.0
R1007200	7200	7.2	1.1	80	1900	50.0	

Notes: ① Static load capacity = 75kN

② For tensile loads, greater maximum strokes can be accommodated, depending on the linear speed

③ Total weight = Basic weight + 3.3 kg (ball screw) or 1.6 kg (roller screw) per 100 mm stroke. All weights are approximate

④ Dimension AB applies (motor axis offset)

Model B125/R125

Right Angle Configuration

	Product Code	Linear Speed (mm/min)	Dynamic Load capacity (kN) ①	Motor		Max Stroke (mm) in Compression ②	Basic Weight (kg) ③
				Power (kW)	Frame Size		
BALL SCREW	B1250380 ④	380	65.0	0.55	80	1900	61.0
	B1250630 ④	630	54.0	0.75	90	2100	61.0
	B1251180	1180	42.5	1.1	90	2300	61.0
	B1252030	2030	34.0	1.5	90	2600	61.0
	B1252370	2370	29.0	1.5	90	2900	61.0
	B1253020	3020	22.8	1.5	90	3200	61.0
	B1253380	3380	20.4	1.5	90	3400	61.0
	B1254100	4100	16.8	1.5	90	3700	61.0
	B1254780	4780	14.4	1.5	90	3400	61.0
B1257130	7130	14.0	2.2	100	2800	68.0	

	Product Code	Linear Speed (mm/min)	Dynamic Load capacity (kN) ①	Motor		Max Stroke (mm) in Compression ②	Basic Weight (kg) ③
				Power (kW)	Frame Size		
ROLLER SCREW	R1250330 ④	330	78.0	0.55	90	1600	61.0
	R1250550 ④	550	64.0	0.75	90	1800	61.0
	R1250890	890	58.0	1.1	90	1900	61.0
	R1251390	1390	50.5	1.5	90	2000	61.0
	R1251760	1760	40.0	1.5	90	2100	61.0
	R1252000	2000	37.0	1.5	90	2200	61.0
	R1252450	2450	28.5	1.5	90	2400	61.0
	R1254440	4440	23.2	2.2	90	2600	61.0
	R1254960	4960	20.7	2.2	90	2600	61.0
R1257180	7180	19.5	3.0	90	2600	72.0	

Notes: ① Static load capacity = 120kN

Model B125/R125

Parallel Configuration

	Product Code	Linear Speed (mm/min)	Dynamic Load capacity (kN) ①	Motor		Max Stroke (mm) in Compression ②	Basic Weight (kg) ③
				Power (kW)	Frame Size		
BALL SCREW	B1250390	390	64.0	0.55	80	1900	78.0
	B1250620	620	55.5	0.75	80	2000	78.0
	B1251090	1090	46.0	1.1	90	2200	82.0
	B1251990	1990	34.0	1.5	90	2600	82.0
	B1253420	3420	29.0	2.2	90	2900	82.0
	B1254040	4040	25.0	2.2	90	3100	82.0
	B1255010	5010	20.0	2.2	90	3300	82.0
	B1255820	5820	17.0	2.2	90	3100	82.0
	B1256860	6860	14.6	2.2	90	2800	82.0
B1258510	8510	11.8	2.2	90	2500	82.0	

	Product Code	Linear Speed (mm/min)	Dynamic Load capacity (kN) ①	Motor		Max Stroke (mm) in Compression ②	Basic Weight (kg) ③
				Power (kW)	Frame Size		
ROLLER SCREW	R0750240	330	80.0	0.55	80	1500	78.0
	R0750620	770	68.0	1.1	80	1600	78.0
	R0750840	1040	67.6	1.5	90	1600	82.0
	R0751010	1530	46.0	1.5	90	2000	82.0
	R0751280	2380	43.6	2.2	90	2040	82.0
	R0751850	2980	34.8	2.2	90	2200	82.0
	R0752400	3610	28.8	2.2	90	2400	82.0
	R0754290	4240	24.5	2.2	90	2500	82.0
	R0754800	5130	20.2	2.2	90	2700	82.0
R0757000	6060	17.1	2.2	90	2740	82.0	

Notes: ① Static load capacity = 120kN

② For tensile loads, greater maximum strokes can be accommodated, depending on the linear speed

③ Total weight = Basic weight + 4.2 kg (ball screw) or 2.2 kg (roller screw) per 100 mm stroke. All weights are approximate

④ Dimension AB applies (motor axis offset)

Model R150

Right Angle Configuration

	Product Code	Linear Speed (mm/min)	Dynamic Load capacity (kN) ①	Motor		Max Stroke (mm) in Compression ②	Basic Weight (kg) ③
				Power (kW)	Frame Size		
ROLLER SCREW	R1500440 ④	440	118.0	1.1	90	2180	90.0
	R1500760 ④	760	92.0	1.5	100	2300	100.0
	R1501160 ④	1160	88.6	2.2	100	2300	100.0
	R1501400	1400	73.5	2.2	100	2650	100.0
	R1501770	1770	58.2	2.2	100	2800	100.0
	R1501910	1910	53.9	2.2	100	3000	100.0
	R1503590	3590	39.1	3.0	100	3300	100.0
	R1504530	4530	30.9	3.0	100	3600	100.0
	R1505060	5060	27.7	3.0	100	3500	100.0
R1507230	7230	25.9	4.0	112	3500	105.0	

Right Angle Configuration

	Product Code	Linear Speed (mm/min)	Dynamic Load capacity (kN) ①	Motor		Max Stroke (mm) in Compression ②	Basic Weight (kg) ③
				Power (kW)	Frame Size		
ROLLER SCREW	R1500420	420	122.0	1.1	90	2000	101.0
	R1500680	680	103.8	1.5	90	2180	101.0
	R1501070	1070	97.4	2.2	90	2200	101.0
	R1501420	1420	73.0	2.2	90	2500	101.0
	R1501810	1810	57.4	2.2	90	2800	101.0
	R1502260	2260	45.8	2.2	90	3200	101.0
	R1502980	2980	34.8	2.2	90	3500	101.0
	R1503610	3610	28.8	2.2	90	3600	101.0
	R1504240	4240	24.5	2.2	90	3700	101.0
R1506060	6060	17.1	2.2	90	3500	101.0	

Notes: ① Static load capacity = 185kN

Model R175

Parallel Configuration

	Product Code	Linear Speed (mm/min)	Dynamic Load capacity (kN) ①	Motor		Max Stroke (mm) in Compression ②	Basic Weight (kg) ③
				Power (kW)	Frame Size		
ROLLER SCREW	R1750460 ④	460	225.0	2.2	112	2200	165.0
	R1750570 ④	570	180.0	2.2	112	2400	165.0
	R1751160 ④	1160	121.0	3.0	100	3000	161.0
	R1751810	1810	103.6	4.0	112	3100	165.0
	R1752020	2020	92.7	4.0	112	3300	165.0
	R1752860	2860	65.4	4.0	112	3800	165.0
	R1753610	3610	51.8	4.0	112	4000	165.0
	R1754560	4560	41.0	4.0	112	4000	165.0
	R1755100	5100	36.7	4.0	112	3800	165.0
	R1757230	7230	35.6	5.5	132	3600	210.0

Right Angle Configuration

	Product Code	Linear Speed (mm/min)	Dynamic Load capacity (kN) ①	Motor		Max Stroke (mm) in Compression ②	Basic Weight (kg) ③
				Power (kW)	Frame Size		
ROLLER SCREW	R1750220	220	210.0	1.1	90	2200	158.0
	R1750650	650	176.0	2.2	100	2400	168.0
	R1751120	1120	140.0	3.0	100	2700	168.0
	R1751330	1330	117.0	3.0	100	3000	168.0
	R1751880	1880	102.8	4.0	112	3100	175.0
	R1752140	2140	83.7	4.0	112	3400	175.0
	R1752680	2680	67.0	4.0	112	3800	175.0
	R1753300	3300	53.4	4.0	112	4000	175.0
	R1754760	4760	40.2	4.0	112	4000	175.0
	R1755690	5690	32.6	4.0	112	3900	175.0

Notes: ① Static load capacity = 335kN

② For tensile loads, greater maximum strokes can be accommodated, depending on the linear speed

③ Total weight = Basic weight + 2.8 kg (R150) or 3.0 kg (R175) per 100 mm stroke. All weights are approximate

④ Dimension AB applies (motor axis)

Model R225

Right Angle Configuration

	Product Code	Linear Speed (mm/min)	Dynamic Load capacity (kN) ①	Motor		Max Stroke (mm) in Compression ②	Basic Weight (kg) ③
				Power (kW)	Frame Size		
ROLLER SCREW	R2250340 ④	340	300.0	2.2	132	3000	307.0
	R2250580 ④	580	240.0	3.0	132	3300	311.0
	R2250880 ④	880	212.5	4.0	112	3500	285.0
	R2251180 ④	1180	158.0	4.0	112	3950	285.0
	R2251820	1820	141.4	5.5	132	4100	306.0
	R2252880	2880	89.3	5.5	132	4800	306.0
	R2253610	3610	71.2	5.5	132	4900	306.0
	R2254560	4560	56.3	5.5	132	4600	306.0
	R2255100	5100	50.4	5.5	132	4600	306.0
R2257230	7230	48.5	7.5	132	4500	316.0	

Right Angle Configuration

	Product Code	Linear Speed (mm/min)	Dynamic Load capacity (kN) ①	Motor		Max Stroke (mm) in Compression ②	Basic Weight (kg) ③
				Power (kW)	Frame Size		
ROLLER SCREW	R2250370	370	280.0	2.2	100	3000	297.0
	R2250750	750	246.0	4.0	112	3200	301.0
	R2251010	1010	196.5	4.0	112	3500	301.0
	R2251250	1250	184.0	4.0	112	3600	301.0
	R2251480	1480	174.4	5.5	132	3700	348.0
	R2252610	2610	124.7	5.5	132	4200	348.0
	R2252860	2860	90.0	5.5	132	4800	348.0
	R2253490	3490	73.8	5.5	132	4900	348.0
	R2254960	4960	51.9	5.5	132	4700	348.0
	R2256720	6720	43.9	5.5	132	4600	348.0

Notes: ① Static load capacity = 450kN

Model R225

Parallel Configuration

	Product Code	Linear Speed (mm/min)	Dynamic Load capacity (kN) ①	Motor		Max Stroke (mm) in Compression ②	Basic Weight (kg) ③
				Power (kW)	Frame Size		
ROLLER SCREW	R2500470 ④	470	402.0	4.0	132	3000	405.0
	R2500790 ④	790	327.0	5.5	132	3200	417.0
	R2501190 ④	1190	294.0	7.5	132	3500	431.0
	R2501440	1440	243.5	7.5	132	3800	431.0
	R2501820	1820	192.8	7.5	132	4100	431.0
	R2502030	2030	172.5	7.5	132	4300	431.0
	R2503000 ④	3000	143.4	9.5	132	4500	441.0
	R2503630	3630	118.6	9.5	132	4800	431.0
	R2505150	5150	99.8	11.0	160	4500	457.0
	R2507330	7330	95.7	15.0	160	4500	467.0

Right Angle Configuration

	Product Code	Linear Speed (mm/min)	Dynamic Load capacity (kN) ①	Motor		Max Stroke (mm) in Compression ②	Basic Weight (kg) ③
				Power (kW)	Frame Size		
ROLLER SCREW	R2500670	670	386.0	5.5	132	3000	483.0
	R2501140	1140	329.0	7.5	132	3300	483.0
	R2501340	1340	262.5	7.5	132	3600	483.0
	R2501860	1860	250.5	9.5	132	3750	483.0
	R2502350	2350	189.8	9.5	132	4100	483.0
	R2502820	2820	165.3	9.5	132	4300	483.0
	R2503520	3520	132.3	9.5	132	4700	483.0
	R2504080	4080	116.5	9.5	132	4800	483.0
	R2504630	4630	95.0	9.5	132	4800	483.0
	R2505560	5560	75.3	9.5	132	4600	483.0

Notes: ① Static load capacity = 600kN

② For tensile loads, greater maximum strokes can be accommodated, depending on the linear speed

③ Total weight = Basic weight + 5.1 kg (R225) or 5.8 kg (R250) per 100 mm stroke. All weights are approximate

④ Dimension AB applies (motor axis)

7. Rolaram Linear Actuator Dimensions

Rolaram - Parallel Motor Configuration - Trunnion Mount

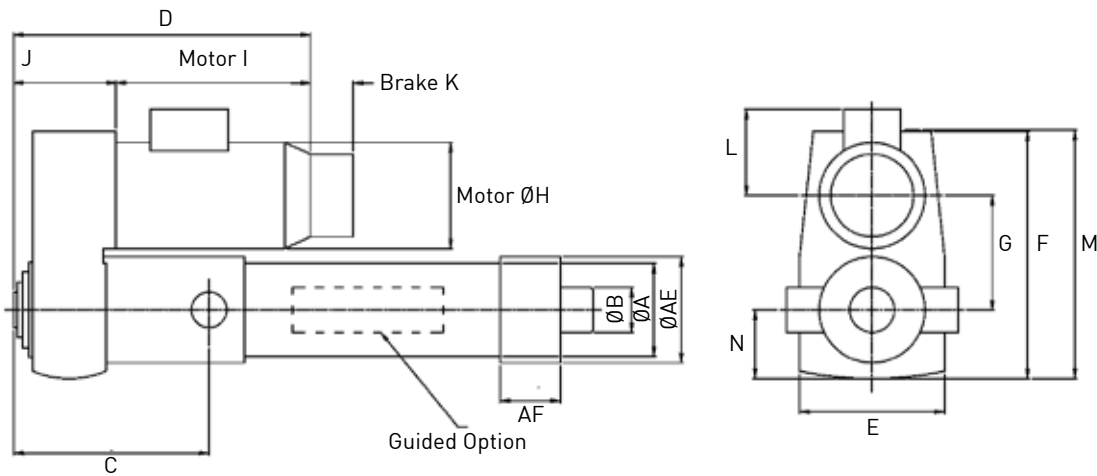

Rolaram Actuators with Roller Screw

Size	R050		R075		R100		R125		R150	R175			R225		R250					
	Frame 63	Frame 80	Frame 63	Frame 71	Frame 71	Frame 80	Frame 80	Frame 90	Frame 90	Frame 90	Frame 100	Frame 112	Frame 100	Frame 112	Frame 132	Frame 132				
AØ	Available on request		Available on request		102		120		145		175		255		275					
BØ					40		50		70		90		110		140		150			
C					208		248		305		320		385		465		560			
D					340		360		385		409		426		463		463		510	
E					158		190		226		226		255		306		350			
F					264		272		337		337		385		385		454		454	
G					122		147		178		178		206		251		281			
HØ					130		145		145		162		162		181		181		203	
I					227		248		242		266		266		303		303		310	
J					118		143		160		160		200		213		307			
K					60		68		68		67		67		75		75		90	
L					113		125		125		137		137		147		147		158	
M					267		324		387		387		438		527		581			
N					77		90		107		107		123		146		172			
AE					110		142		160		185		206		270		285			
AF					125		110		145		180		165		180		190			

Rolaram Actuators with Ball Screw

Size	B050		B075		B100		B125							
	Frame 63	Frame 80	Frame 63	Frame 71	Frame 71	Frame 80	Frame 80	Frame 90						
AØ	Available on request		Available on request		102		120		145					
BØ					75		92		106					
C					208		248		305					
D					340		360		385		409		426	
E					158		190		226					
F					264		272		337		337		385	
G					122		147		178					
HØ					130		145		145		162		162	
I					227		248		242		266		266	
J					118		143		160		160			
K					60		68		68		67		75	
L					113		125		125		137		137	
M					267		324		387		387			
N					77		90		107		107			
AE					110		142		160		160			
AF					125		110		145		145			

- Notes 1. All dimensions are in millimetres (mm) unless otherwise stated.
 2. "Frame" refers to IEC motor frame size.
 3. Dimensions subject to change without notice.

Rolaram® - Parallel Motor Configuration - Rear Clevis Mount

Rolaram with rear clevis mounting enables the actuator to be configured for double clevis arrangements. Details below are for the B050 Rolaram Actuator only. For all other sizes contact Power Jacks.

B050 - Rolaram®

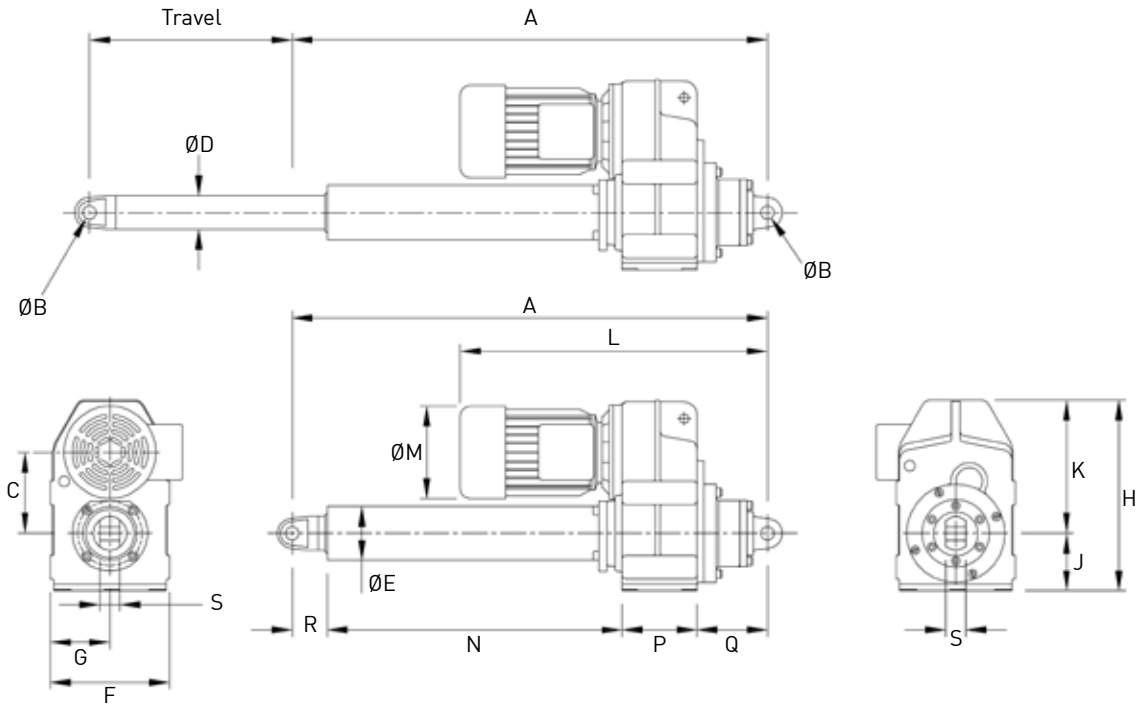

Standard Clevis, Top Plate and Threaded Ends are available on request.

Frame	63	71	80
A	432 + Stroke	432 + Stroke	432 + Stroke
B	20 HB	20 HB	20 HB
C	120	120	120
D	50	50	50
E	80	80	80
F	176	176	176
G	88	88	88
H	282	282	282
J	85	85	85
K	197	197	197
L	471	499	543
M	122	137	158
N	160 + Stroke	160 + Stroke	160+ Stroke
P	112	112	112
Q	110	110	110
R	50	50	50
S	25	25	25

- Notes 1. All dimensions are in millimetres (mm) unless otherwise stated.
- 2. "Frame" refers to IEC motor frame size.
- 3. Dimensions subject to change without notice.

Rolaram® - Right Angled Motor Configuration - Trunnion Mount

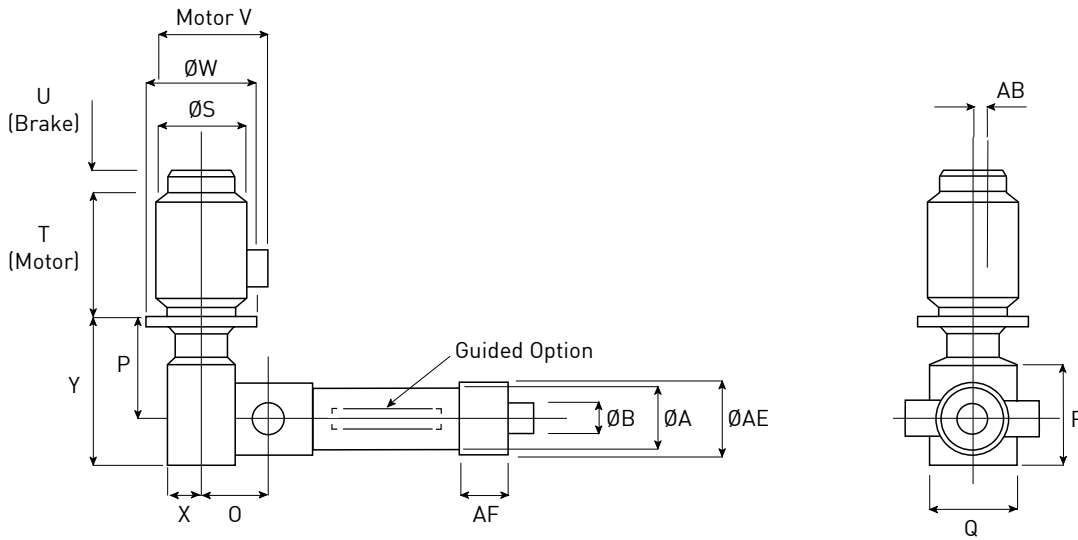

2.2.7.3.1. Roller Screw and Ball Screw

Size	R/B 050		R/B 075		R/B 100		R/B 125		R/B 150		
	Frame 71	Frame 80	Frame 80	Frame 90	Frame 90	Frame 100	Frame 90	Frame 100	Frame 112	Frame 125	Frame 150
O	157.5		190		210		236.5				
P	155 max	209 max	233 max	245 max	243 max	255 max	285 max	295 max	292 max		
Q	110		140		140		170				
R	158		193		193		235				
SØ	145	162	162	181	181	203	181	203	228		
T	207	232	232	275	275	275	275	305	325		
U	68	67	67	75	75	90	75	90	95		
V	186	223	223	226	226	261	226	261	273		
WØ	160	200	200	200	200	250	200	250	250		
X	62		60		72		85				
Y	220.5 max	274.5 max	316 max	328 max	326 max	338 max	383 max	393 max	390 max		
AB	10		12		12		18				
AE	110		142		160		185				
AF	125		110		145		180				

Size	R/B 175			R/B 225		R/B 250	
	Frame 100	Frame 112	Frame 132	Frame 112	Frame 132	Frame 132	Frame 160
O	300			365		370	
P	270 max	343 max	363 max	332 max	427 max	383 max	383 max
Q	210			240		280	
R	291			338		406	
SØ	203	228	266	228	266	266	326
T	305	325	395	325	395	395	521
U	90	95	122	95	122	122	130
V	261	273	323	273	323	323	380
WØ	250	250	300	250	300	300	350
X	107			128		151	
Y	391 max	464 max	484 max	468 max	563 max	546 max	546 max
AB	22			26		32	
AE	206			270		285	
AF	165			180		190	

- Notes 1. All dimensions are in millimetres (mm) unless otherwise stated.
- 2. "Frame" refers to IEC motor frame size.
- 3. Dimensions subject to change without notice.

End Fittings and Mountings

Top Plate

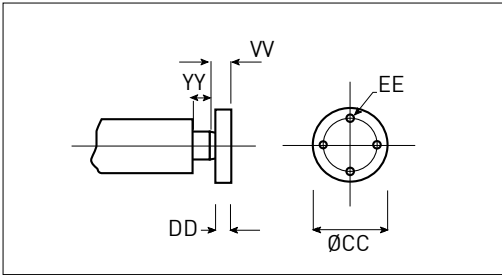

Clevis End

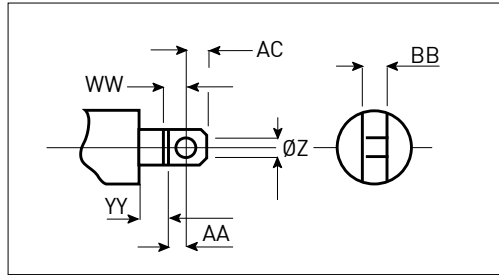

Screwed End

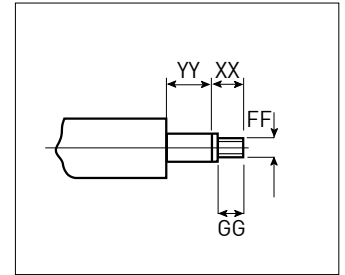

Trunnion

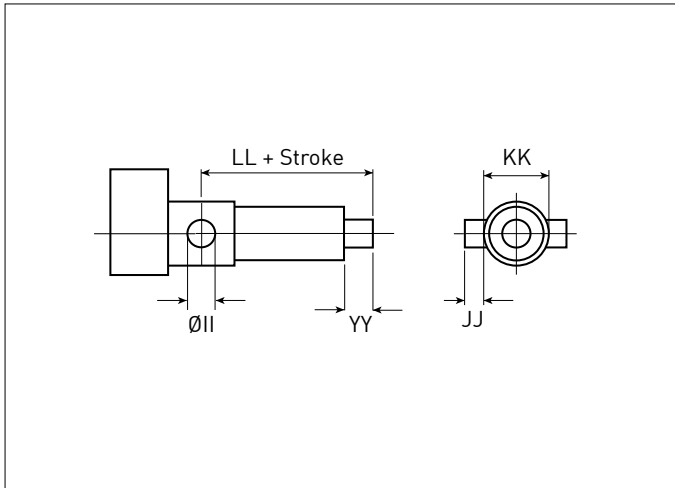

Trunnion Feet/End Cap Foot

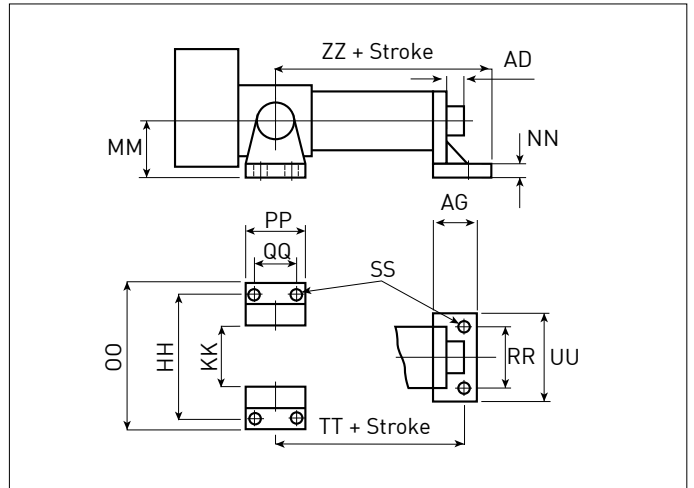

Size	075	100	125	150	175	225	250
ZØ (H7)	20	28	35	42	55	70	80
AA	23	32	38	47	62	78	90
BB	25	30	35	40	50	70	80
CCØ	105 (145)	130 (175)	170 (210)	220	270	300	330
DD	14	18	22	26	33	33	39
EE	4 X Ø13.5 X 80 PCD (115)	4 X Ø18 X 100 PCD (140)	4 X Ø22 X 130 PCD (165)	4 X Ø26 X 170 PCD	4 X Ø33 X 205 PCD	6 X Ø33 X 235 PCD	6 X Ø39 X 260 PCD
FF	M24 X 3	M36 X 4	M36 X 4	M48 X 5	M68 X 6	M80 X 6	M80 X 6
GG	35	40	50	60	75	90	125
HH	211	290	325	324	355	530	610
IIØ (F7)	35	45	60	70	95	110	125
JJ	32	45	50	60	80	90	105
KK	115	160	175	190	195	260	310
LL	300	305	363	495	750	850	750
MM	85	100	110	120	150	180	195
NN	14	20	25	35	40	45	50
OO	251	350	389	412	453	640	742
PP	100	140	154	238	308	350	400
QQ	60	80	90	150	210	240	268
RR	120	145	180	210	260	280	350
SS	6 X Ø13.5	6 X Ø22	6 X Ø26	6 X Ø33	6 X Ø39	6 X Ø45	6 X Ø52
TT	281	305	407	505	767	903	790
UU	160	205	250	300	370	410	500
VV	20	23	27	32	40	52	60
WW	28	37	45	54	72	90	105
XX	40	45	57	67	85	102	140
YY	50	41	24	50	58	32	60
ZZ	301	335	442	550	822	968	865
AC	20	28	35	45	55	70	80
AD	39	40.5	7.5	35	41	12	35
AG	70	90	85	110	135	155	180

Notes 1. Dimensions in brackets refer to Ball Screw Models.

8. Rolaram® Accessories and Options

Limit Switches

Standard Rolaram® Actuator Limit Switch

- Inductive proximity switches
- Cylindrical design M18 x 1
- Standard housing made from brass or stainless steel.
- DC-voltage
- Sizes: A = 60 mm, B = 51.5 mm

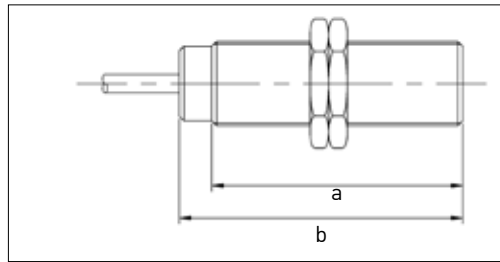

Rolaram® Limit Switch Technical Data

Parameter	Data
Type	Four-wire PNP/NPN/NO/NC programmable
Housing Material	Brass housing
Nominal Sensing Distance, S_n	5mm
Weight (kg)	0.120
Connecting Cable	4 core x 0.34mm ² , 2m long (other lengths available on request)
Degree of Protection	IP 68
Sensing Distance, S_r	0 → 4mm
Repeat Accuracy, R	3% of S_r
Differential Travel, H	1 15% of S_r
Operating Temperature	-25 → + 80°C
Output State Indicator	LED
Voltage, U_o	12 → 24VDC
Operating Voltage, U_b (including residual ripple)	10 → 38VDC
Switching power, I	0 → 200mA, including overload and short circuit connection
Voltage Drop, U_d (output controlled)	2.6V
Residual Current, I_r (output locked)	-
Idle Current, I_s	10mA
Maximum Switching Frequency, f	2000Hz
Delay Times	Stand-by delay t_v = 5ms, switch-on time t_{on} = 1.15ms, switch-off time t_{off} = 0.35ms

Optional Rolaram® Actuator Limit Switch

Other limit switches can be supplied to suit most applications e.g:

- Different sizes, shape, design and enclosure electro-mechanical limit switches
- Inductive proximity sensor
- Hazardous Area rated electro-mechanical limit switch
- High or low temperature rated limit switches or sensors. For all of these options consult Power Jacks for details

Encoders for Rolaram® Actuators

Encoders for Rolaram linear actuators can be provided fitted to the rear of the electric motor (beneath the cowling). For further details please consult Power Jacks.

Optional Materials for Rolaram® Actuator Construction

As with all other Power Jacks products these actuators can be manufactured with alternative materials to meet the most demanding application. Consult Power Jacks for advice.

9. Special Rolaram® Designs and Applications

Actuator

R150 model, roller screw version, in-line drive.

Application

Driving reciprocating, double acting paint pumps in the first all-electric paint mix facility in Europe.

Linear Actuation Requirements

The dynamic load is 17.9 kN in both directions, at a linear speed of 3 metres/minute

and a continuous duty cycle of 24 hours/day, 365 days/year. Each pump delivers 40 litres of paint/minute at 12 bar, 12 cycles/minute. The paint shop output is 30 cars/hour

(Phase 1) and 60 cars/hour (Phase 2).

Solution

Each pump is driven by a special R150 Rolaram actuator and a total of 31 actuator and pump systems are installed.

The actuator's features are:

- In-line configuration, minimizing the installation footprint
- Completely sealed unit, ensuring no contamination of the pumped medium
- Intrinsically safe, eliminating explosion risk
- Fitted with a keyed screw mechanism

An electro mechanical solution was preferred to pneumatics/hydraulics due to significantly reduced running costs, high life and reliability, high efficiency, low maintenance, low paint degradation and quiet operation.

Actuator

B100 model, ball screw version, parallel drive.

Application

Full body, multi purpose X ray examination table.

Linear Actuation Requirements

The dynamic load is 65 kN and high positional accuracy is required to achieve a defined axial play of the ram. Due to the clinical environment, the ability to tilt and elevate at the same time is unique and no other table on the marketplace is available with this feature. Operating in a medical environment, a major requirement of the actuators is low noise and the units cannot exceed 60 dB.

Solution

Two B100 ball screw Rolaram actuators, both parallel drive configurations, are fitted on each X ray table and they are synchronized for horizontal and vertical positioning through a complex servo control system. The actuators are tested to withstand 8 times the maximum load, without catastrophic failure. Due to space constraints, they are of a compact design and conform to strict aesthetic criteria.

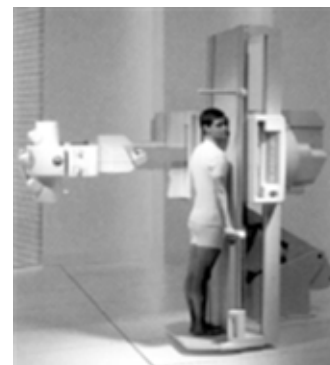
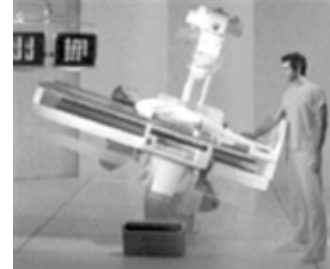

Actuator

Spring return actuator, ball screw version, in-line drive.

Application

Failsafe operation of ventilation dampers.

Linear Actuation Requirements

The actuator opens and closes the damper and maintains a 3 kN load to ensure that the damper is sealed. The damper must open and close in 2 seconds and operate at 250°C for 1 hour. In the event of power failure, the actuator must failsafe in the closed position.



Solution

One off ball screw actuator is fitted onto each damper. The actuator contains a pre-loaded spring and is fitted with a high temperature brake motor. The internal spring and drive configuration will allow the ram to retract automatically in the event of power failure. Three adjustable limit switch positions are provided and the stroke can be set within the allowable 120 mm, by adjusting these switches. All components are selected for the appropriate approved temperature requirement. The actuator has a fire test certificate for operation at 250°C for 1 hour.

Actuator

R175 model, roller screw version, right angle drive.

Application

Positioning a weir gate for water level adjustment.

Linear Actuation Requirements

The actuator moves a dynamic load of 150 kN (static load of 330 kN), at a linear speed of 240 mm/minute, has a stroke of 2700 mm and a life requirement of 40 years.

Solution

One actuator is fitted on each weir gate and has several special features:

- Universal joint at the ram end to compensate for misalignment and to resist the load torque
- Geared motor drive with hand wind facility
- Positional indication and end of travel limit switches
- Non contaminating grease

This application is in a remote location and an electro mechanical solution was preferred over hydraulics due to low power requirements, no expensive hydraulic power pack, no hydraulic fluid leakage i.e. no water contamination and minimal maintenance.



PRECISION SCREW JACKS . ELECTRIC LINEAR ACTUATORS .
PLANETARY ROLLER SCREWS . SPIRAL BEVEL GEARBOXES .

Power Jacks are an industry leader in the manufacture of quality industrial lifting, positioning, material handling and power transmission equipment.

Our products are supplied globally to most industry sectors including nuclear, water, oil & gas, chemical, defence, steel, aluminium, automotive and others.

DESIGN WITH POWER

Power Jacks Ltd
Balmacassie Commercial Park
Ellon, AB41 8BX
Scotland (UK)

Tel: +44 (0)1358 285100

www.powerjacks.com
sales@powerjacks.com

PJLAB-ROLARAM-EN-01



FM 23810

All information in this document is subject to change without notice .