

Drop-out center design coupling

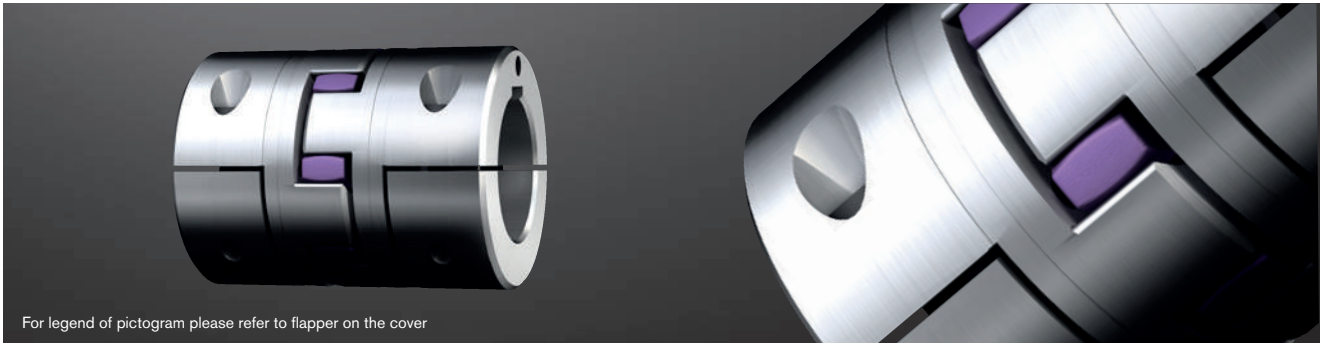

For legend of pictogram please refer to flapper on the cover

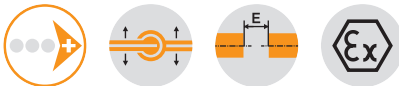

Components

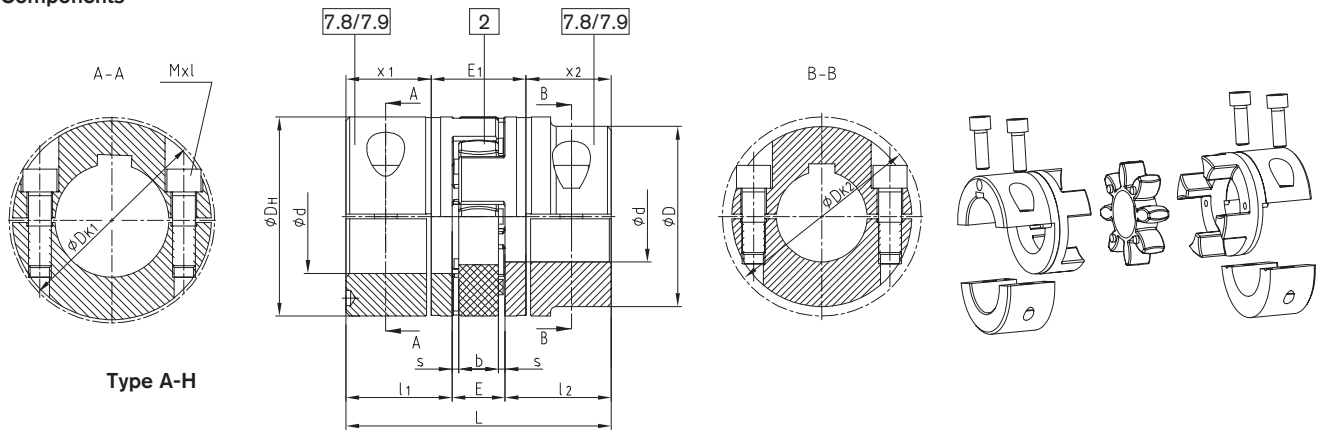

ROTEX® Type A-H														
Size	Max. finish bore d	Dimensions [mm]											Cap screws DIN EN ISO 4762	
		L	l <sub>1</sub> , l <sub>2</sub>	E	b	s	D <sub>H</sub>	D	DK <sub>1</sub>	DK <sub>2</sub>	x <sub>1</sub> , x <sub>2</sub>	E <sub>1</sub>	Mxl	Tightening torque T <sub>A</sub> [Nm]
19	20	66	25	16	12	2.0	40	—	46	—	17.5	31	M6x16	14
24	28	78	30	18	14	2.0	55	—	57.5	—	22.5	33	M6x20	14
28	38	90	35	20	15	2.5	65	—	73	—	25.5	39	M8x25	35
38	45	114	45	24	18	3.0	80	—	83.5	—	35.5	43	M8x30	35
42	50	126	50	26	20	3.0	95	85	—	93.5	39	48	M10x30	69
	55							—	97	M10x35				
48	55	140	56	28	21	3.5	105	95	—	105	45	50	M12x35	120
	60							—	108.5	M12x40				
55	65	160	65	30	22	4.0	120	110	—	119.5	50	60	M12x40	120
	70							—	122	M12x45				
65	70	185	75	35	26	4.5	135	115	—	123.5	60	65	M12x40	120
	80							—	132.5	M12x45				
75	80	210	85	40	30	5.0	160	135	—	147.5	67.5	75	M16x50	295
	90							—	158	M16x50				
90	90	245	100	45	34	5.5	200	160	—	176	81.5	82	M20x60	580
	110							—	197	M20x60				
100 <sup>1)</sup>	110	270	110	50	38	6.0	225	180	—	185.5	84	102	M16x50	295
110 <sup>1)</sup>	120	295	120	55	42	6.5	255	200	—	208	90	115	M20x60	580
125 <sup>1)</sup>	140	340	140	60	46	7.0	290	230	—	242.5	105	130	M24x70	1000

CAUTION:

With maximum bore the feather keyways are offset to each other by approx. 5°  
Hub material up to size 90: steel, from size 100: GJS

7.8 = Shell clamping hub without feather key max. circumferential speed of v = 35 m/s.

From a circumferential speed of v = 25 m/s the frictional torque of shaft/hub has to be reviewed. Please consult with KTR engineering department.

7.9 = Shell clamping hub with feather key max. circumferential speed of v = 35 m/s. From a circumferential speed of v = 25 m/s dynamic balancing is required.

Speed: max. circumferential speed of 25 m/s on the outside diameter D<sub>H</sub> of the coupling

<sup>1)</sup> From size 100: 4 clamping screws for each clamping hub

Ordering example:	ROTEX® 38	A-H	98 ShA	7.8	Ø38	7.8	Ø30
	Coupling size	Type	Spider hardness	Hub design	Finish bore	Hub design	Finish bore

# Legend of pictograms



Torsionally rigid



Light-weight



Protected against corrosion



Torsionally flexible

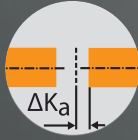

Axial compensation



Electrically insulating



Highly flexible

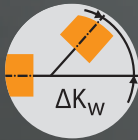

Angular compensation



Maximum speed



Damping vibrations

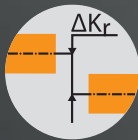

Radial compensation



No eddy current losses



Axial plug-in



Shiftable at standstill



Torque limiter slipping



Consider shaft distance



Double-cardanic



Torque limiter with synchronous ratcheting



Relatively short shaft distance

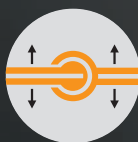

Radial disassembly  
Ease of service



Torque limiter with idle rotation type

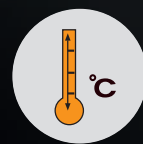

Maximum operating temperature



Standard drop-out center lengths available



Hardened surface



High speeds



Available in accordance with API



Accuracy X %



Backlash-free



Complying with ATEX  
For details refer to our ATEX leaflet



Consider axial displacement



Shear type, separating, slipping



Maintenance-free



Additional features compared to standard version

Displacements

Axial displacement  $\Delta K_a$

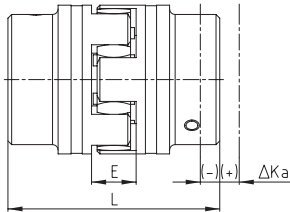

$$L_{\max.} = L + \Delta K_a$$

Radial displacement  $\Delta K_r$

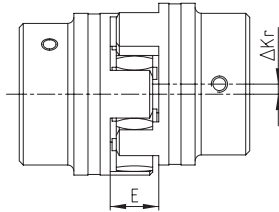

Angular displacement  $\Delta K_w$  [degree]

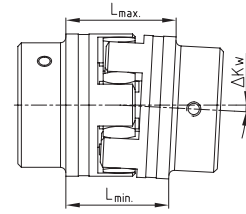

$$\Delta K_w \text{ [mm]} = L_{\max} - L_{\min}$$

Displacements for spider 92 and 98 Shore A

ROTEX® size	14	19	24	28	38	42	48	55	65	90	100	110	125	140	160	180	
Max. axial displacement $\Delta K_a$ [mm]	-0.5 +1.0	-0.5 +1.2	-0.5 +1.4	-0.7 +1.5	-0.7 +1.8	-1.0 +2.0	-1.0 +2.1	-1.0 +2.2	-1.0 +2.6	-1.5 +3.0	-1.5 +3.4	-1.5 +3.8	-2.0 +4.2	-2.0 +4.6	-2.0 +5.0	-2.5 +5.7	-3.0 +6.4
Max. radial displacement with $n=1500$ rpm $\Delta K_r$ [mm]	0.17	0.20	0.22	0.25	0.28	0.32	0.36	0.38	0.42	0.48	0.50	0.52	0.55	0.60	0.62	0.64	0.68
Max. angular displacement with $n=1500$ rpm $\Delta K_w$ [degree]	1.2	1.2	0.9	0.9	1.0	1.0	1.1	1.1	1.2	1.2	1.2	1.2	1.3	1.3	1.2	1.2	1.2
$\Delta K_w$ [mm]	0.67	0.82	0.85	1.05	1.35	1.70	2.00	2.30	2.70	3.30	4.30	4.80	5.60	6.50	6.60	7.60	9.00

Displacements of spider 64 Shore D

ROTEX® size	14	19	24	28	38	42	48	55	65	75	90	100	110	125	140	160	180
Max. axial displacement $\Delta K_a$ [mm]	-0.5 +1.0	-0.5 +1.2	-0.5 +1.4	-0.7 +1.5	-0.7 +1.8	-1.0 +2.0	-1.0 +2.1	-1.0 +2.2	-1.0 +2.6	-1.5 +3.0	-1.5 +3.4	-1.5 +3.8	-2.0 +4.2	-2.0 +4.6	-2.0 +5.0	-2.5 +5.7	-3.0 +6.4
Max. radial displacement with $n=1500$ rpm $\Delta K_r$ [mm]	0.11	0.13	0.15	0.18	0.21	0.23	0.25	0.27	0.30	0.34	0.36	0.37	0.40	0.43	0.45	0.46	0.49
Max. angular displacement with $n=1500$ rpm $\Delta K_w$ [degree]	1.1	1.1	0.8	0.8	0.9	0.9	1.0	1.0	1.1	1.1	1.1	1.1	1.2	1.2	1.1	1.1	1.1
$\Delta K_w$ [mm]	0.57	0.76	0.76	0.90	1.25	1.40	1.80	2.00	2.50	3.00	3.80	4.30	5.30	6.00	6.10	7.10	8.00

Displacements for spider PA, PEEK

ROTEX® size	14	19	24	28	38	42	48	55	65	75	90	100	110	125	140
Max. axial displacement $\Delta K_a$ [mm]	-0.5 +1.0	-0.5 +1.2	-0.5 +1.4	-0.7 +1.5	-0.7 +1.8	-1.0 +2.0	-1.0 +2.1	-1.0 +2.2	-1.0 +2.6	-1.5 +3.0	-1.5 +3.4	-1.5 +3.8	-2.0 +4.2	-2.0 +4.6	-2.0 +5.0
Max. radial displacement with $n=1500$ rpm $\Delta K_r$ [mm]	0.08	0.10	0.11	0.12	0.14	0.16	0.18	0.19	0.21	0.24	0.25	0.26	0.27	0.30	0.31
Max. angular displacement with $n=1500$ rpm $\Delta K_w$ [degree]	0.60	0.45	0.45	0.50	0.50	0.55	0.55	0.55	0.60	0.60	0.60	0.60	0.65	0.65	0.60
$\Delta K_w$ [mm]	0.33	0.41	0.42	0.52	0.67	0.85	1.00	1.15	1.35	1.65	2.15	2.40	2.80	3.25	3.30

The above-mentioned displacement figures of the flexible ROTEX® couplings are standard values taking into account the load of the coupling up to the rated torque  $T_{KN}$  and an operating speed  $n = 1500$  rpm along with an ambient temperature of  $+30^\circ\text{C}$ . The displacement figures may only be used one by one - if they appear simultaneously, they must be limited in proportion. Care should be taken to maintain the distance dimension  $E$  accurately in order to allow for axial clearance of the coupling while in operation. Detailed mounting instructions are shown on our homepage [www.ktr.com](http://www.ktr.com).

# ROTEX®

## Flexible jaw couplings

### Properties of standard spiders

ROTEX® 14



ROTEX® 19

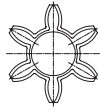

ROTEX® 24 - 65

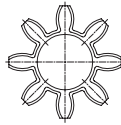

ROTEX® 75 - 160

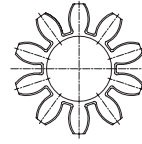



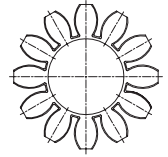

ROTEX® 180



#### Degree of hardness



Spider type (Shore hardness)	92 Shore A (T-PUR®)	92 Shore A
	 T-PUR®	
Size	14 to 180	14 to 90
Material	T-PUR®	Polyurethane (PUR)
Permissible temperature range		
Permanent temperature	-50 °C to +120 °C	-40 °C to +90 °C
Short-term temperature	-50 °C to +150 °C	-50 °C to +120 °C
Features	<ul style="list-style-type: none"> <li>- significantly higher service life expectancy</li> <li>- very good temperature resistance</li> <li>- improved damping of vibrations</li> <li>- good damping, average flexibility</li> <li>- suitable for all hub materials</li> </ul>	<ul style="list-style-type: none"> <li>- good damping, average flexibility</li> <li>- suitable for all hub materials</li> </ul>

Spider type (Shore hardness)	98 Shore A (T-PUR®) <sup>1)</sup>	98 Shore A <sup>1)</sup>
	 T-PUR®	
Size	14 to 180	14 to 90
Material	T-PUR®	Polyurethane (PUR)
Permissible temperature range		
Permanent temperature	-50 °C to +120 °C	-30 °C to +90 °C
Short-term temperature	-50 °C to +150 °C	-40 °C to +120 °C
Features	<ul style="list-style-type: none"> <li>- significantly higher service life expectancy</li> <li>- very good temperature resistance</li> <li>- improved damping of vibrations</li> <li>- transmission of high torques with average damping</li> <li>- recommended hub material: steel, GJL and GJS</li> </ul>	<ul style="list-style-type: none"> <li>- transmission of high torques with average damping</li> <li>- recommended hub material: steel, GJL and GJS</li> </ul>

Spider type (Shore hardness)	64 Shore D (T-PUR®)
	 T-PUR®
Size	14 to 180
Material	T-PUR®
Permissible temperature range	
Permanent temperature	-50 °C to +120 °C
Short-term temperature	-50 °C to +150 °C
Features	<ul style="list-style-type: none"> <li>- significantly higher service life expectancy</li> <li>- very good temperature resistance</li> <li>- improved damping of vibrations</li> <li>- transmission of very high torques with low damping</li> <li>- recommended hub material: steel and GJS</li> </ul>

Technical data of standard spiders

92 Shore A spider made of T-PUR® and PUR															
ROTEX® size	Max. speed		Torsion angle $\phi$ with		Torque [Nm]				Damping power P <sub>KW</sub> [W] <sup>3)</sup>	Relative damping $\psi$	Resonance factor V <sub>R</sub>	Torsion spring stiffness C dyn. [Nm/rad]			
	v=35 m/s cast material	v=40 m/s steel	T <sub>KN</sub>	T <sub>K max</sub>	DIN 740 <sup>1)</sup>			T <sub>K max</sub> <sup>2)</sup>				1.0 T <sub>KN</sub>	0.75 T <sub>KN</sub>	0.5 T <sub>KN</sub>	0.25 T <sub>KN</sub>
					Rated T <sub>KN</sub>	Max. T <sub>K max</sub>	Vibratory T <sub>KW</sub>								
14	22200	25400	6.4°	10°	7.5	15	2.0	22.5	–			0.38x10 <sup>3</sup>	0.31x10 <sup>3</sup>	0.24x10 <sup>3</sup>	0.14x10 <sup>3</sup>
19	16700	19000			10	20	2.6	30	4.8			1.28x10 <sup>3</sup>	1.05x10 <sup>3</sup>	0.8x10 <sup>3</sup>	0.47x10 <sup>3</sup>
24	12100	13800			35	70	9.1	105	6.6			4.86x10 <sup>3</sup>	3.98x10 <sup>3</sup>	3.01x10 <sup>3</sup>	1.79x10 <sup>3</sup>
28	10100	11500			95	190	25	285	8.4			10.9x10 <sup>3</sup>	8.94x10 <sup>3</sup>	6.76x10 <sup>3</sup>	4.01x10 <sup>3</sup>
38	8300	9500			190	380	49	570	10.2			21.05x10 <sup>3</sup>	17.26x10 <sup>3</sup>	13.05x10 <sup>3</sup>	7.74x10 <sup>3</sup>
42	7000	8000			265	530	69	795	12.0			23.74x10 <sup>3</sup>	19.47x10 <sup>3</sup>	14.72x10 <sup>3</sup>	8.73x10 <sup>3</sup>
48	6350	7250			310	620	81	930	13.8			36.7x10 <sup>3</sup>	30.09x10 <sup>3</sup>	22.75x10 <sup>3</sup>	13.49x10 <sup>3</sup>
55	5550	6350			410	820	107	1230	15.6			50.7x10 <sup>3</sup>	41.59x10 <sup>3</sup>	31.45x10 <sup>3</sup>	18.64x10 <sup>3</sup>
65	4950	5650	3.2°	5°	625	1250	163	1875	18.0	0.80	7.90	97.1x10 <sup>3</sup>	79.65x10 <sup>3</sup>	60.2x10 <sup>3</sup>	35.7x10 <sup>3</sup>
75	4150	4750			1280	2560	333	3840	21.6			113.3x10 <sup>3</sup>	92.9x10 <sup>3</sup>	70.3x10 <sup>3</sup>	41.65x10 <sup>3</sup>
90	3300	3800			2400	4800	624	7200	30.0			190.1x10 <sup>3</sup>	155.9x10 <sup>3</sup>	117.9x10 <sup>3</sup>	69.9x10 <sup>3</sup>
100	2950	3350			3300	6600	858	9900	36.0			253.1x10 <sup>3</sup>	207.5x10 <sup>3</sup>	156.9x10 <sup>3</sup>	93x10 <sup>3</sup>
110	2600	2950			4800	9600	1248	14400	42.0			415.5x10 <sup>3</sup>	336.9x10 <sup>3</sup>	257.6x10 <sup>3</sup>	177.4x10 <sup>3</sup>
125	2300	2600			6650	13300	1729	19950	48.0			647.7x10 <sup>3</sup>	537.3x10 <sup>3</sup>	412.2x10 <sup>3</sup>	277.5x10 <sup>3</sup>
140	2050	2350			8550	17100	2223	25650	54.6			813.4x10 <sup>3</sup>	670.2x10 <sup>3</sup>	519.7x10 <sup>3</sup>	351.7x10 <sup>3</sup>
160	1800	2050			12800	25600	3328	38400	75.0			1298x10 <sup>3</sup>	1104x10 <sup>3</sup>	901.9x10 <sup>3</sup>	655.7x10 <sup>3</sup>
180	1550	1800			18650	37300	4849	55950	78.0			2327x10 <sup>3</sup>	1981x10 <sup>3</sup>	1618x10 <sup>3</sup>	1176x10 <sup>3</sup>

98 Shore A spider made of T-PUR® and PUR															
ROTEX® size	Max. speed		Torsion angle $\phi$ with		Torque [Nm]				Damping power P <sub>KW</sub> [W] <sup>3)</sup>	Relative damping $\psi$	Resonance factor V <sub>R</sub>	Torsion spring stiffness C dyn. [Nm/rad]			
	v=35 m/s cast material	v=40 m/s steel	T <sub>KN</sub>	T <sub>K max</sub>	DIN 740 <sup>1)</sup>			T <sub>K max</sub> <sup>2)</sup>				1.0 T <sub>KN</sub>	0.75 T <sub>KN</sub>	0.5 T <sub>KN</sub>	0.25 T <sub>KN</sub>
					Rated T <sub>KN</sub>	Max. T <sub>K max</sub>	Vibratory T <sub>KW</sub>								
14	22200	25400	6.4°	10°	12.5	25	3.3	37.5	–			0.56x10 <sup>3</sup>	0.46x10 <sup>3</sup>	0.35x10 <sup>3</sup>	0.21x10 <sup>3</sup>
19	16700	19000			17	34	4.4	51	4.8			2.92x10 <sup>3</sup>	2.39x10 <sup>3</sup>	1.81x10 <sup>3</sup>	1.07x10 <sup>3</sup>
24	12100	13800			60	120	16	180	6.6			9.93x10 <sup>3</sup>	8.14x10 <sup>3</sup>	6.16x10 <sup>3</sup>	3.65x10 <sup>3</sup>
28	10100	11500			160	320	42	480	8.4			26.77x10 <sup>3</sup>	21.95x10 <sup>3</sup>	16.6x10 <sup>3</sup>	9.84x10 <sup>3</sup>
38	8300	9500			325	650	85	975	10.2			48.57x10 <sup>3</sup>	39.83x10 <sup>3</sup>	30.11x10 <sup>3</sup>	17.85x10 <sup>3</sup>
42	7000	8000			450	900	117	1350	12.0			54.5x10 <sup>3</sup>	44.69x10 <sup>3</sup>	33.79x10 <sup>3</sup>	20.03x10 <sup>3</sup>
48	6350	7250			525	1050	137	1575	13.8			65.3x10 <sup>3</sup>	53.54x10 <sup>3</sup>	40.48x10 <sup>3</sup>	24x10 <sup>3</sup>
55	5550	6350			685	1370	178	2055	15.6			95x10 <sup>3</sup>	77.9x10 <sup>3</sup>	58.88x10 <sup>3</sup>	34.9x10 <sup>3</sup>
65	4950	5650	3.2°	5°	940	1880	244	2820	18.0	0.80	7.90	129.5x10 <sup>3</sup>	106.2x10 <sup>3</sup>	80.3x10 <sup>3</sup>	47.6x10 <sup>3</sup>
75	4150	4750			1920	3840	499	5760	21.6			197.5x10 <sup>3</sup>	162x10 <sup>3</sup>	122.5x10 <sup>3</sup>	72.6x10 <sup>3</sup>
90	3300	3800			3600	7200	936	10800	30.0			312.2x10 <sup>3</sup>	256x10 <sup>3</sup>	193.6x10 <sup>3</sup>	114.7x10 <sup>3</sup>
100	2950	3350			4950	9900	1287	14850	36.0			383.3x10 <sup>3</sup>	314.3x10 <sup>3</sup>	237.6x10 <sup>3</sup>	140.9x10 <sup>3</sup>
110	2600	2950			7200	14400	1872	21600	42.0			805.9x10 <sup>3</sup>	663.1x10 <sup>3</sup>	515.3x10 <sup>3</sup>	360.5x10 <sup>3</sup>
125	2300	2600			10000	20000	2600	30000	48.0			1207x10 <sup>3</sup>	1003x10 <sup>3</sup>	773.1x10 <sup>3</sup>	552.5x10 <sup>3</sup>
140	2050	2350			12800	25600	3328	38400	54.6			1549x10 <sup>3</sup>	1283x10 <sup>3</sup>	979.8x10 <sup>3</sup>	674.1x10 <sup>3</sup>
160	1800	2050			19200	38400	4992	57600	75.0			2481x10 <sup>3</sup>	2137x10 <sup>3</sup>	1781x10 <sup>3</sup>	1275x10 <sup>3</sup>
180	1550	1800			28000	56000	7280	84000	78.0			4220x10 <sup>3</sup>	3635x10 <sup>3</sup>	3031x10 <sup>3</sup>	2170x10 <sup>3</sup>

64 Shore D spider made of T-PUR® and PUR															
ROTEX® size	Max. speed		Torsion angle $\phi$ with		Torque [Nm]				Damping power P <sub>KW</sub> [W] <sup>3)</sup>	Relative damping $\psi$	Resonance factor V <sub>R</sub>	Torsion spring stiffness C dyn. [Nm/rad]			
	v=35 m/s cast material	v=40 m/s steel	T <sub>KN</sub>	T <sub>K max</sub>	DIN 740 <sup>1)</sup>			T <sub>K max</sub> <sup>2)</sup>				1.0 T <sub>KN</sub>	0.75 T <sub>KN</sub>	0.5 T <sub>KN</sub>	0.25 T <sub>KN</sub>
					Rated T <sub>KN</sub>	Max. T <sub>K max</sub>	Vibratory T <sub>KW</sub>								
14	22200	25400	4.5°	7.0°	16	32	4.2	48	9.0			0.76x10 <sup>3</sup>	0.62x10 <sup>3</sup>	0.47x10 <sup>3</sup>	0.28x10 <sup>3</sup>
19	16700	19000			21	42	5.5	63	7.2			5.35x10 <sup>3</sup>	4.39x10 <sup>3</sup>	3.32x10 <sup>3</sup>	1.97x10 <sup>3</sup>
24	12100	13800			75	150	19.5	225	9.9			15.11x10 <sup>3</sup>	12.39x10 <sup>3</sup>	9.37x10 <sup>3</sup>	5.55x10 <sup>3</sup>
28	10100	11500			200	400	52	600	12.6			27.52x10 <sup>3</sup>	22.57x10 <sup>3</sup>	17.06x10 <sup>3</sup>	10.12x10 <sup>3</sup>
38	8300	9500			405	810	105	1215	15.3			70.15x10 <sup>3</sup>	57.52x10 <sup>3</sup>	43.49x10 <sup>3</sup>	25.78x10 <sup>3</sup>
42	7000	8000			560	1120	146	1680	18.0			79.9x10 <sup>3</sup>	65.5x10 <sup>3</sup>	49.52x10 <sup>3</sup>	29.35x10 <sup>3</sup>
48	6350	7250			655	1310	170	1965	20.7			95.5x10 <sup>3</sup>	78.3x10 <sup>3</sup>	59.22x10 <sup>3</sup>	35.1x10 <sup>3</sup>
55	5550	6350			825	1650	215	2475	23.4			107.9x10 <sup>3</sup>	88.5x10 <sup>3</sup>	66.9x10 <sup>3</sup>	39.66x10 <sup>3</sup>
65	4950	5650	2.5°	3.6°	1175	2350	306	3525	27.0	0.75	8.50	151.1x10 <sup>3</sup>	123.9x10 <sup>3</sup>	93.7x10 <sup>3</sup>	55.53x10 <sup>3</sup>
75	4150	4750			2400	4800	624	7200	32.4			248.2x10 <sup>3</sup>	203.5x10 <sup>3</sup>	153.9x10 <sup>3</sup>	91.2x10 <sup>3</sup>
90	3300	3800			4500	9000	1170	13500	45.0			674.5x10 <sup>3</sup>	553.1x10 <sup>3</sup>	418.2x10 <sup>3</sup>	247.9x10 <sup>3</sup>
100	2950	3350			6185	12370	1608	18555	54.0			861.2x10 <sup>3</sup>	706.2x10 <sup>3</sup>	533.9x10 <sup>3</sup>	316.5x10 <sup>3</sup>
110	2600	2950			9000	18000	2340	27000	63.0			1230x10 <sup>3</sup>	1001x10 <sup>3</sup>	773.1x10 <sup>3</sup>	531.4x10 <sup>3</sup>
125	2300	2600			12500	25000	3250	37500	72.0			1749x10 <sup>3</sup>	1436x10 <sup>3</sup>	1149x10 <sup>3</sup>	832.1x10 <sup>3</sup>
140	2050	2350			16000	32000	4160	48000	81.9			2312x10 <sup>3</sup>	1929x10 <sup>3</sup>	1521x10 <sup>3</sup>	1082x10 <sup>3</sup>
160	1800	2050			24000	48000	6240	72000	112.5			3415x10 <sup>3</sup>	2961x10 <sup>3</sup>	2471x10 <sup>3</sup>	1830x10 <sup>3</sup>
180	1550	1800			35000	70000	9100	105000	117.0			5670x10 <sup>3</sup>	4917x10 <sup>3</sup>	4103x10 <sup>3</sup>	3038x10 <sup>3</sup>

<sup>1)</sup> see catalogue page 15  
<sup>2)</sup> ≤ 1000 load cycles  
<sup>3)</sup> with +30°C



Temperature factor S <sub>t</sub>											
	-50 °C	-30 °C +30 °C	+40 °C	+50 °C	+60 °C	+70 °C	+80 °C	+90 °C	+100 °C	+110 °C	+120 °C
T-PUR®	1.0	1.0	1.1	1.2	1.3	1.45	1.6	1.8	2.1	2.5	3.0
PUR	–	1.0	1.2	1.3	1.4	1.55	1.8	2.2	–	–	–

Unless explicitly specified in your order, we will supply spiders with Shore hardness 92 Shore A T-PUR®.  
 For circumferential speeds exceeding v = 30 m/s dynamic balancing is required. For circumferential speeds exceeding v = 35 m/s only steel or nodular iron.

# ROTEX®

## Flexible jaw couplings

### Technical data and properties of special spiders

		
Designation	PA	PEEK
Material	Polyamide	Polyetheretherketone
Permissible temperature range		
Permanent temperature	-20 °C to +130 °C <sup>1)</sup>	up to +180 °C (ATEX up to +160 °C)
Short-term temperature	-30 °C to +150 °C <sup>1)</sup>	up to +250 °C
Features	<ul style="list-style-type: none"> <li>- small twisting angle and high torsion spring stiffness</li> <li>- transmission of very high torques with very low damping</li> <li>- good resistance to chemicals <sup>1)</sup></li> <li>- recommended hub material: steel</li> <li>- high restoring forces with displacements</li> </ul>	<ul style="list-style-type: none"> <li>- small twisting angle and high torsion spring stiffness</li> <li>- transmission of very high torques with very low damping</li> <li>- highly temperature-resistant, resistant to hydrolysis</li> <li>- good resistance to chemicals</li> <li>- recommended hub material: steel</li> <li>- high restoring forces with displacements</li> </ul>

<sup>1)</sup> different properties depending on compound

Torques			
ROTEX® size	PA, PEEK		
	T <sub>KN</sub> [Nm]	T <sub>K max</sub> [Nm]	T <sub>KW</sub> [Nm]
14	22	44	5.5
19	30	60	8.0
24	105	210	27.5
28	280	560	73
38	565	1130	147
42	785	1570	204
48	915	1830	238
55	1200	2400	312
65	1645	3290	427
75	2560	5130	667
90	6300	12600	1640
100	8650	17300	2250
110	10500	21000	2730
125	13000	26000	3380

Temperature factor S <sub>t</sub>												
	-50 °C	-30 °C +30 °C	+40 °C	+50 °C	+60 °C	+70 °C	+80 °C	+90 °C	+100 °C	+110 °C	+120 °C	+180 °C
PA	-	1.0	1.15	1.25	1.4	1.6	1.9	2.3	3.0	-	-	-
PEEK	-	1.0	1.0	1.0	1.0	1.0	1.0	1.0	1.0	1.0	1.0	1.0

### Installation of spider

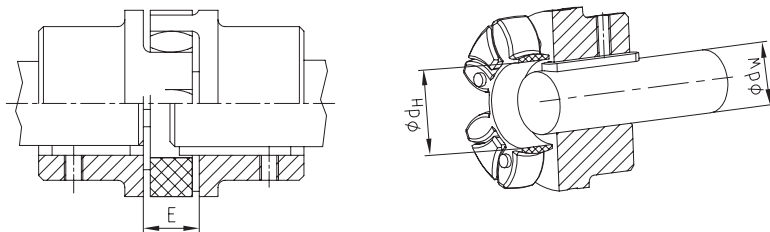

Shaft  $\phi d_H$  with feather key (acc. to DIN 6885 sheet 1) protruding into the spider  $\phi d_H$

Assembly dimensions																	
ROTEX® size	14	19	24	28	38	42	48	55	65	75	90	100	110	125	140	160	180
Distance dimension E	13	16	18	20	24	26	28	30	35	40	45	50	55	60	65	75	85
Dimension d <sub>H</sub>	10	18	27	30	38	46	51	60	68	80	100	113	127	147	165	190	220
Dimension d <sub>VV</sub> <sup>2)</sup>	7	12	20	22	28	36	40	48	55	65	80	95	100	120	135	160	185

<sup>2)</sup> If the shaft diameter is smaller than or equal to dimension d<sub>H</sub>, one shaft end or both shaft ends may protrude with the feather keyway into the spider.

## Selection of standard IEC motors

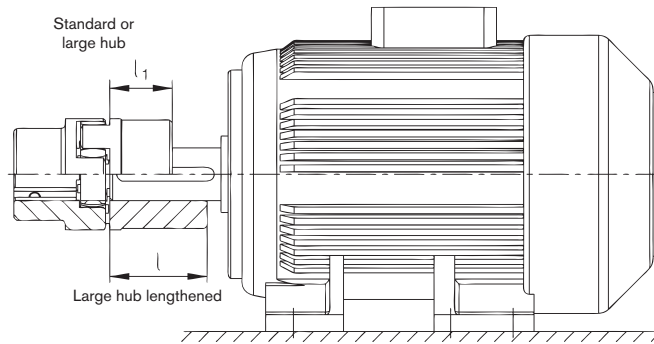

ROTEX® couplings for standard IEC motors, protection class IP 54/IP 55 (spider 92 Shore A)

Size	A. C. motor 50 Hz		Motor power n= 3000 rpm 2 poles		ROTEX® coupling size	Motor power n= 1500 rpm 4 poles		ROTEX® coupling size	Motor power n= 1000 rpm 6 poles		ROTEX® coupling size	Motor power n= 750 rpm 8 poles		ROTEX® coupling size
	Shaft end d x l [mm]		Power P [kW]	Torque T [Nm]		Power P [kW]	Torque T [Nm]		Power P [kW]	Torque T [Nm]		Power P [kW]	Torque T [Nm]	
	2 poles	4, 6, 8 poles												
56	9 x 20		0.09	0.32	9 <sup>1)</sup>	0.06	0.43	9 <sup>1)</sup>	0.037	0.43	9 <sup>1)</sup>			
			0.12	0.41		0.09	0.64		0.045	0.52				
63	11 x 23		0.18	0.62	14	0.12	0.88	14	0.06	0.7	14			
			0.25	0.86		0.18	1.3		0.09	1.1				
71	14 x 30		0.37	1.3	14	0.25	1.8	14	0.18	2	14	0.09	1.4	14
			0.55	1.9		0.37	2.5		0.25	2.8		0.12	1.8	
80	19 x 40		0.75	2.5	19	0.55	3.7	19	0.37	3.9	19	0.18	2.5	19
			1.1	3.7		0.75	5.1		0.55	5.8		0.25	3.5	
90S	24 x 50		1.5	5	19	1.1	7.5	19	0.75	8	19	0.37	5.3	19
90L			2.2	7.4		1.5	10		1.1	12		0.55	7.9	
100L	28 x 60		3	9.8	24	2.2	15	24	1.5	15	24	0.75	11	24
			4	13		3	20		2.2	22		1.1	16	
112M			4	13	24	4	27	24	2.2	22	24	1.5	21	24
132S			5.5	18		5.5	36		3	30		2.2	30	
132M	38 x 80		7.5	25	28	7.5	49	28	4	40	28	3	40	28
										5.5		55		
160M	42 x 110		11	36	38	11	72	38	7.5	75	38	4	54	38
			15	49		15	98		11	109		5.5	74	
160L			18.5	60	38	15	98	38	11	109	38	7.5	100	38
180M	48 x 110		22	71		18.5	121							
180L					42	22	144	42	15	148	42	11	145	42
200L	55 x 110		30	97		30	196					18.5	181	
			37	120					22	215				
225S	55 x 110				48	37	240	48			48	18.5	244	48
225M	60 x 140	60 x 140	45	145		45	292					30	293	
250M	60 x 140	65 x 140	55	177	48	55	356	55	37	361	55	30	392	65
280S			75	241		75	484		65 <sup>2)</sup>	45		438	65 <sup>2)</sup>	
280M		75 x 140	90	289	55	90	581	55	55	535	55	45	587	75
315S			110	353		110	707		75	75		727	75	
315M			132	423	65	132	849	65	90	873	65	75	971	90
	65 x 140	80 x 170	160	513		160	1030					110	1070	
315L			200	641	75	200	1290	75	132	1280	75	110	1420	90
										160		1550	90	
315		85 x 170	250	802	75	250	1600	75	200	1930	75	160	2070	100
			315	1010		315	2020					250	2410	
			355	1140	90	355	2280	90			90			110
355	75 x 140	95 x 170	400	1280		400	2570					315	3040	
			500	1600	100	500	3210	100	400	3850	100	315	4060	125
			560	1790		560	3580					450	4330	
400	80 x 170	110 x 210	630	2020	100	630	4030	100	500	4810	100	400	5150	140
			710	2270		710	4540					560	5390	
			800	2560	110	800	5120	110	630	6060	110	500	6420	160
450	90 x 170	120 x 210	900	2880		900	5760					710	6830	
			1000	3200	1000	6400			800	7690	160	630	8090	

The coupling selection is based on an ambient temperature up to +30 °C. The selection is based on a minimum safety factor of 2 versus the max. coupling torque ( $T_{K \max}$ ). A detailed selection is possible according to catalogue, page 14 et seqq. Drives with periodical torque curves must be selected according to DIN 740 part 2. If requested, KTR will perform the selection. Torque T = rated torque according to Siemens catalogue M 11 · 1994/95.

<sup>1)</sup> For dimensions see ROTEX® GS series

<sup>2)</sup> For motor hub made of steel see page 40

### Cylindrical bores and spline bores

ROTEX® size		Stock programme of cylindrical finish bores [mm] H7 feather keyway acc. to DIN 6885 sheet 1 [JS9] and thread for setscrews																																					
Material	Un-bored	Ø6	Ø8	Ø9	Ø10	Ø11	Ø12	Ø14	Ø15	Ø16	Ø17	Ø18	Ø19	Ø20	Ø22	Ø24	Ø25	Ø26	Ø30	Ø32	Ø35	Ø38	Ø40	Ø42	Ø45	Ø48	Ø50	Ø55	Ø60	Ø65	Ø70	Ø75	Ø80	Ø85	Ø90	Ø100			
14	Sint	•	•	•	•	•	•	•	•	•																													
	Al-H	•	•	•	•	•	•	•	•	•																													
19	Sint	•																																					
	Al-D	•	•	•	•	•	•	•	•	•	•	•	•	•	•	•	•	•	•	•	•	•	•	•	•	•	•	•	•	•	•	•	•	•	•	•	•	•	•
	St	•	•	•	•	•	•	•	•	•	•	•	•	•	•	•	•	•	•	•	•	•	•	•	•	•	•	•	•	•	•	•	•	•	•	•	•	•	•
24	Sint	•																																					
	Al-D	•			•	•	•	•	•	•	•	•	•	•	•	•	•	•	•	•	•	•	•	•	•	•	•	•	•	•	•	•	•	•	•	•	•	•	•
	St	•			•	•	•	•	•	•	•	•	•	•	•	•	•	•	•	•	•	•	•	•	•	•	•	•	•	•	•	•	•	•	•	•	•	•	•
28	Al-D	•																																					
	St	•																																					
38	GJL	•																																					
	St	•																																					
42	GJL	•																																					
	St	•																																					
48	GJL	•																																					
	St	•																																					
55	GJL	•																																					
	St	•																																					
65	GJL	•																																					
	St	•																																					
75	GJL	•																																					
	St	•																																					
90	GJL	•																																					
	St	•																																					

Basic programme of SAE involute spline												
Spline code	Size	Pitch circle	Pitch	No. of teeth	Angle	Spline code	Size	Pitch circle	Pitch	No. of teeth	Angle	
PH-S	5/8"	14.28	16/32	9	30°	PS-S	1 1/2"	35.98	12/24	17	30°	
PI-S	3/4"	17.46	16/32	11	30°	PD-S	1 1/2"	36.51	16/32	23	30°	
PB-S	7/8"	20.63	16/32	13	30°	PE-S	1 3/4"	42.86	16/32	27	30°	
PB-BS	1"	23.81	16/32	15	30°	PK-S	1 3/4"	41.275	8/16	13	30°	
PJ	1 1/8"	26.98	16/32	17	30°	PT-C <sup>1)</sup>	2"	47.625	8/16	15	30°	
PC-S	1 1/4"	29.63	12/24	14	30°	PQ-C <sup>1)</sup>	2 1/4"	53.975	8/16	17	30°	
PA-S	1 3/8"	33.33	16/32	21	30°							

Basic programme of spline bores acc. to DIN 5482										
Size	Pitch circle	Module	No. of teeth	Profile correction	Size	Pitch circle	Module	No. of teeth	Profile correction	
A 17 x 14	14.40	1.6	9	+0.600 <sup>2)</sup>	A 35 x 31	31.50	1.75	18	+0.676	
A 20 x 17	19.20	1.6	12	-0.2	A 40 x 36	38.00	1.9	20	+0.049	
A 25 x 22	22.40	1.6	14	+0.550	A 45 x 41	44.00	2	22	+0.181	
A 28 x 25	26.25	1.75	15	+0.302	A 50 x 45	48.00	2	24	+0.181	
A 30 x 27	28.00	1.75	16	+0.327						

Basic programme of spline bores acc. to DIN 5480								
Spline code	Pitch circle	Module	No. of teeth	Spline code	Pitch circle	Module	No. of teeth	
20 x 1 x 18 x 7H	18.0	1	18	40 x 2 x 18 x 8H	36.0	2	18	
20 x 1.25 x 14 x 7H	17.5	1.25	14	45 x 2 x 21 x 7H	41.0	2	21	
25 x 1.25 x 18 x 7H	22.5	1.25	18	48 x 2 x 22 x 9H	44.0	2	22	
28 x 1.25 x 21 x 7H	26.25	1.25	21	50 x 2 x 24 x 8H	48.0	2	24	
30 x 2 x 14 x 7H	26.0	2	14	60 x 2 x 28 x 8H	56.0	2	28	
32 x 2 x 14 x 8H	28.0	2	14	75 x 3 x 24 x 7H	72.0	3	24	
35 x 2 x 16 x 8H	32.0	2	16	80 x 3 x 25 x 8H	75.0	3	25	

Basic programme of spline bores acc. to DIN 9611 - ISO 500 (p.t.o. shaft connection)				
Size	Width of keyway	No. of teeth	Tip circle	Root circle
1 3/8"	8.69	6	34.93	29.65
1 3/8"	-	21	34.95	34.80 <sup>3)</sup>
1 3/4"	11.07	6	44.45	37.74
1 3/4"	-	20	45.20	40.20

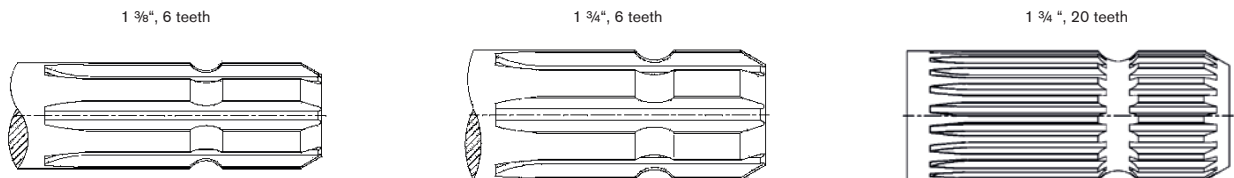

Spline clamping hubs are often adapted to the shafts of hydraulic pumps/hydraulic motor shafts. Please contact us for the respective hub length of the spline code!

<sup>1)</sup> For clamping hubs only, with plug-in hubs use code PT or PQ.

<sup>2)</sup> Profile correction different from DIN

<sup>3)</sup> Similar to code PA-S



**Morskate®**



Any questions? Please contact us.

**Morskate Aandrijvingen BV**

Oosterveldsingel 47A  
7558 PJ Hengelo (Ov)  
The Netherlands

NL

T +31 (0)74 - 760 11 11  
info@morskateaandrijvingen.nl  
www.morskateaandrijvingen.nl

DE

T +49 692 - 222 34 95  
info@morskateantriebstechnik.de  
www.morskateantriebstechnik.de

EN

T +31 (0)74 - 760 11 11  
info@morskatedrivetechnology.com  
www.morskatedrivetechnology.com