

Roller link
Maglia interna

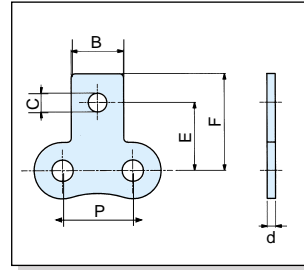

Pin link
Maglia esterna

APPLICATION
APPLICAZIONE **G**

ISO N°	Regina Chain N° Codice Catena Regina	Pitch Passo		Roller Diameter Diametro Rullo	Inside Width Larghezza interna	Attachment N° Codice Attacco	Attachment on roller link Attacco sulla maglia interna	Attachment on pin link Attacco sulla maglia esterna	Materials Materiali	Attachment dimensions Dimensioni attacchi						Add. weight per attachment Peso aggiuntivo per attacco	Availability Disponibilità
		mm	P " inches							Dr mm	W mm	B mm	C mm	d1 mm	d mm		

EUROPEAN SERIES - SINGLE PITCH SERIE EUROPEA - PASSO SEMPLICE

05B-1	105	8,00	-	5,00	3,00	M35/M1	x	x	cs	5,10	2,50	0,70	0,70	5,00	7,50	0,0003	●
06B-1	C121	9,525	3/8	6,35	5,72	160		x	cs	9,00	4,10	-	1,03	14,40	24,00	0,002	●
06B-1	C121	9,525	3/8	6,35	5,72	1.000	x		cs,ss	9,00	4,10	1,27	-	14,40	24,00	0,002	●
06B-1	C121	9,525	3/8	6,35	5,72	M35/M1	x	x	cs	8,00	3,50	1,27	1,03	9,50	13,50	0,001	●
83	54	12,7	1/2	7,75	4,88	165	x		cs	9,50	4,10	1,40	-	12,40	17,10	0,002	●
83	54	12,7	1/2	7,75	4,88	M35/M1	x	x	cs,ss	9,50	4,30	1,40	1,40	12,40	17,10	0,001	●
08B-1	126	12,7	1/2	8,51	7,75	136	x		cs	9,50	3,50	-	1,40	14,10	19,20	0,002	●
08B-1	126	12,7	1/2	8,51	7,75	137	x		cs	9,50	5,00	-	1,40	14,10	19,20	0,002	●
08B-1	126	12,7	1/2	8,51	7,75	173	x		cs	9,50	3,05	-	1,40	8,00	11,50	0,002	○
08B-1	126	12,7	1/2	8,51	7,75	185	x		cs	9,50	5,50	-	1,40	14,10	19,20	0,002	●
08B-1	126	12,7	1/2	8,51	7,75	193	x		cs	9,50	5,50	1,63	-	14,10	19,20	0,002	●
08B-1	126	12,7	1/2	8,51	7,75	M35/M1	x	x	cs,ss	9,50	4,30	1,63	1,40	14,10	19,20	0,002	●
-	8126	12,7	1/2	8,51	7,75	M35/M1	x		cs	9,50	4,30	1,63	1,40	14,10	19,20	0,003	●
10B-1	136	15,875	5/8	10,16	9,65	M35/M1	x	x	cs,ss	14,10	5,20	1,63	1,53	15,90	23,70	0,003	●
-	8136	15,875	5/8	10,16	9,65	M35/M1	x		cs	14,10	5,20	-	1,53	15,90	23,70	0,006	●
12B-1	140	19,05	3/4	12,07	11,68	166	x		ss	28,00	8,00	-	1,80	17,90	29,00	0,004	●
12B-1	140	19,05	3/4	12,07	11,68	M35/M1	x	x	cs,ss	16,00	5,60	1,90	1,90	17,90	26,20	0,004	●
-	8140	19,05	3/4	12,07	11,68	M35/M1	x		cs	16,00	5,60	-	1,90	17,90	26,20	0,010	●
16B-1	147	25,4	1	15,88	17,02	M35/M1	x		cs,ss	19,00	6,80	3,80	3,00	26,00	35,00	0,020	●
20B-1	152	31,75	1 1/4	19,05	19,56	M35/M1	x		cs	25,25	8,40	-	3,35	31,75	42,00	0,020	○
24B-1	157	38,1	1 1/2	25,40	25,40	150	x		cs	38,50	10,50	-	5,10	44,00	61,95	0,081	○
32B-1	165	50,8	2	29,21	30,99	138	x		cs	35,00	7,00	-	6,15	65,00	79,50	0,096	○

AMERICAN SERIES - SINGLE PITCH SERIE AMERICANA - PASSO SEMPLICE

06C-1	A35	9,525	3/8	5,08	4,77	M35/M1	x	x	cs,ss	7,90	2,80	1,27	1,27	9,50	13,50	0,001	●
-	A35 SB	9,525	3/8	5,08	4,77	M35/M1	x		cs	7,90	2,80	1,27	-	9,50	13,50	0,001	●
08A-1	A40	12,70	1/2	7,95	7,85	M35/M1	x	x	cs,ss	9,50	3,30	1,53	1,53	12,70	17,50	0,001	●
-	A40 SB	12,70	1/2	7,95	7,85	M35/M1	x		cs	9,50	3,30	1,53	1,53	12,70	17,50	0,001	●
10A-1	A50	15,875	5/8	10,16	9,40	M35/M1	x	x	cs,ss	14,10	5,20	2,00	2,00	15,90	23,70	0,004	●
-	A50 SB	15,875	5/8	10,16	9,40	M35/M1	x		cs	14,10	5,20	2,00	-	15,90	23,70	0,004	●
10A-1	A50	15,875	5/8	10,16	9,40	169A	x		ss	12,65	5,20	-	2,00	15,90	23,00	0,004	●
10A-1	A50	15,875	5/8	10,16	9,40	170A	x		ss	12,65	5,20	2,00	-	15,90	23,00	0,004	●
12A-1	A60	19,05	3/4	11,91	12,57	M35/M1	x	x	cs,ss	15,85	5,60	2,30	2,30	18,25	26,20	0,006	●
-	A60 OR	19,05	3/4	11,91	12,70	M35/M1	x		cs	15,85	5,60	-	2,30	18,25	26,20	0,006	○
-	A60 SB	19,05	3/4	11,91	12,57	M35/M1	x		cs,ss	15,85	5,60	2,30	-	18,25	26,20	0,006	●
16A-1	A80	25,40	1	15,88	15,75	M35/M1	x	x	cs,ss	18,85	6,80	3,10	3,10	24,60	35,00	0,012	●
16A-1	A80 SB	25,40	1	15,88	15,75	M35/M1	x		cs,ss	18,85	6,80	3,10	-	24,60	35,00	0,012	●
16A-1	A80	25,40	1	15,88	15,75	171	x		cs	18,85	M8	-	3,10	24,60	35,00	0,011	●
20A-1	A100	31,75	1 1/4	19,05	18,90	M35/M1	x	x	cs	22,25	8,80	3,80	3,80	31,75	42,00	0,024	●
24A-1	A120	38,10	1 1/2	22,23	25,22	138	x		cs	28,45	10,00	-	4,60	22,00	31,00	0,030	○
120H	A120 H	38,10	1 1/2	22,23	25,22	M35/M1	x	x	cs	28,45	11,00	4,60	4,60	36,50	50,50	0,038	○
28A-1	A140	44,45	1 3/4	25,40	25,22	M35/M1	x	x	cs	34,85	11,50	5,45	5,45	44,50	61,50	0,067	○
32A-1	A160	50,80	2	28,58	31,55	M35/M1	x	x	cs	37,85	13,10	6,15	6,15	50,80	68,15	0,095	○

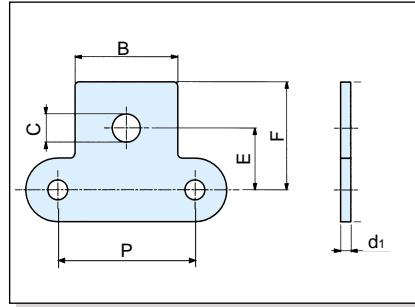
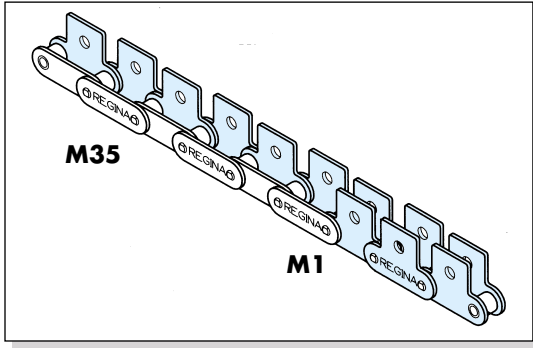

Roller link
Maglia interna

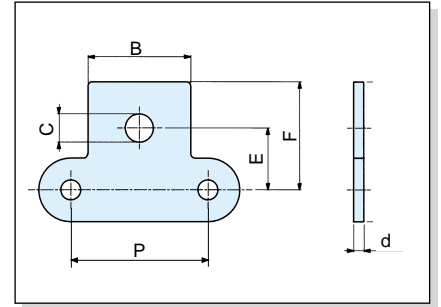

Pin link
Maglia esterna

APPLICATION
APPLICAZIONE **G**

ISO N°	Regina Chain N° Codice Catena Regina	Pitch Passo		Roller Diameter Diámetro Rullo	Inside Width Larghezza interna	Attachment N° Codice Attacco	Attachment on roller link Attacco sulla maglia interna	Attachment on pin link Attacco sulla maglia esterna	Materials Materiali	Attachment dimensions Dimensioni attacchi						Add. weight per attachment Peso aggiuntivo per attacco	Availability Disponibilità
		mm	P " inches							Dr mm	W mm	B mm	C mm	d1 mm	d mm		

EUROPEAN SERIES - DOUBLE PITCH SERIE EUROPEA - PASSO DOPPIO

208B	2126	25,40	1	8,51	7,75	148		x	cs	19,05	9,52	-	1,40	39,75	49,75	0,006	●
208B	2126	25,40	1	8,51	7,75	150		x	cs	19,00	7,00	-	1,40	14,80	19,30	0,006	●
210B	2136	31,75	1 1/4	10,61	9,65	137		x	cs	18,00	5,00	-	1,53	27,35	34,20	0,006	●

AMERICAN SERIES - DOUBLE PITCH SERIE AMERICANA - PASSO DOPPIO

C208AS	C2040	25,40	1	7,95	7,85	M35/M1	x	x	cs,ss	19,00	5,20	1,53	1,53	11,10	19,50	0,003	●
C208AS	C2040	25,40	1	7,95	7,85	155		x	cs	19,00	10,50	-	1,53	25,50	34,10	0,005	○
C210AS	C2050	31,75	1 1/4	10,16	9,40	M35/M1	x	x	cs,ss	25,40	6,40	2,00	2,00	14,30	24,60	0,006	●
C212A-H	C2060H	38,10	1 1/2	11,91	12,57	M35/M1	x	x	cs	28,00	8,80	3,25	3,25	17,50	30,00	0,011	●
C212A-H	SS C2060H	38,10	1 1/2	11,91	12,57	M35/M1		x	ss	28,00	8,80	3,25	3,25	17,50	30,00	0,011	●
C216AS	C 2080	50,80	2	15,88	15,75	187		x	cs	37,85	9,30	-	3,15	27,20	39,70	0,025	○
C216A-H	C2080H	50,80	2	15,88	15,75	155		x	cs	38,00	11,00	-	4,00	22,20	32,00	0,018	○
C216A-H	C2080H	50,80	2	15,88	15,75	M35/M1	x	x	cs	38,00	11,00	3,80	3,80	22,20	39,70	0,030	●
C220A-H	C2100H	63,50	2 1/2	19,05	18,90	M35/M1	x	x	cs	47,50	13,10	4,80	4,80	28,60	50,00	0,058	●
C224A-H	C2120H	76,20	3	22,23	22,23	M35/M1	x	x	cs	57,00	15,00	5,45	5,45	33,30	58,90	0,092	○

ROLLER CHAINS WITH M35-2 \ M2 TYPE ATTACHMENTS

CATENE A RULLI CON ATTACCHI TIPO M35-2 \ M2

APPLICATION
APPLICAZIONE **G,D1**

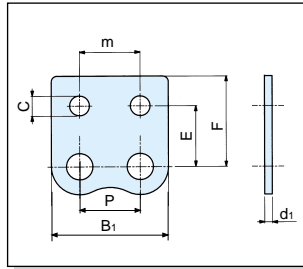
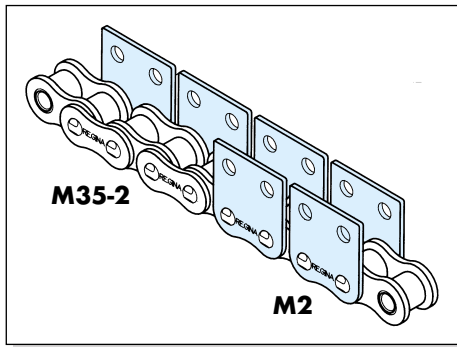

Roller link
Maglia interna

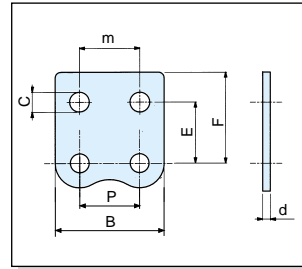

Pin link
Maglia esterna

ISO N°	Regina Chain N° Codice Catena Regina	Pitch Passo		Roller Diameter Diámetro Rullo	Inside Width Larghezza interna	Attachment N° Codice Attacco	Attachment on roller link Attacco sulla maglia interna	Attachment on pin link Attacco sulla maglia esterna	Materials Materiali	Attachment dimensions Dimensioni attacchi							Add. weight per attachment Peso aggiuntivo per attacco	Availability Disponibilità	
		P	Dr							B1	B	C	d1	d	E	F			m
		mm	" inches	mm	mm				mm	mm	mm	mm	mm	mm	mm	mm	kg		

EUROPEAN SERIES - SINGLE PITCH SERIE EUROPEA - PASSO SEMPLICE

83	54	12,70	1/2	7,75	4,88	151		x	cs		22,20	4,00	-	1,40	12,15	17,00	12,70	0,002	●	
08B-1	126	12,70	1/2	8,51	7,75	1011A		x	ss		-	23,05	4,60	-	1,40	14,10	19,20	12,70	0,004	●
08B-1	126	12,70	1/2	8,51	7,75	M35-2 / M2	x	x	cs,ss	24,45	23,05	4,30	1,63	1,40	14,10	19,20	12,70	0,004	●	
08B-1	8126	12,70	1/2	8,51	7,75	M35-2 / M2		x	cs		23,05	4,30	-	1,40	14,10	19,20	12,70	0,005	●	
10B-1	136	15,875	5/8	10,16	9,65	M35-2 / M2	x	x	cs,ss	30,00	28,60	5,20	1,63	1,53	15,90	23,70	15,90	0,006	●	
10B-1	8136	15,875	5/8	10,16	9,65	M35-2 / M2		x	cs		28,60	5,20	-	1,53	15,90	23,70	15,90	0,009	●	
12B-1	140	19,05	3/4	12,07	11,68	M35-2 / M2	x	x	cs,ss	35,00	34,90	5,60	1,90	1,90	17,90	32,00	19,00	0,012	●	
12B-1	8140	19,05	3/4	12,07	11,68	M35-2 / M2		x	cs		-	34,90	5,60	-	1,90	17,90	32,00	19,00	0,012	●
16B-1	147	25,40	1	15,88	17,02	M35-2 / M2	x	x	cs,ss	46,00	45,85	6,80	3,80	3,00	26,00	36,75	25,40	0,035	●	
20 B-1	152	31,75	1 1/4	19,05	19,56	154		x	cs		-	57,00	10,50	-	4,00	33,00	47,30	31,75	0,066	○
40 B-1	175	63,50	2 1/2	39,37	38,10	140		x	cs		-	115,00	15,00	-	8,00	50,00	66,00	80,00	0,367	○
40 B-1	175	63,50	2 1/2	39,37	38,10	154		x	cs		-	115,00	17,00	-	8,00	49,50	76,00	80,00	0,393	○
40 B-1	175	63,50	2 1/2	39,37	38,10	155		x	cs		-	90,00	16,00	-	7,80	49,50	76,00	57,00	0,295	○
40 B-1	175	63,50	2 1/2	39,37	38,10	156		x	cs		-	112,00	17,00	-	7,80	50,00	66,00	50,00	0,307	○
40 B-1	C175	63,50	2 1/2	39,37	38,10	136		x	cs		-	115,35	13,50	-	7,80	42,00	59,07	85,00	0,246	○
40 B-1	C175	63,50	2 1/2	39,37	38,10	142		x	cs		-	115,00	17,00	-	8,00	49,50	76,00	80,00	0,355	○
48 B-1	181	76,20	3	48,26	45,72	136	x		cs	140,10	-	29,24	12,00	-	60,00	92,10	76,20	0,757	○	

Typical applications
Applicazioni comuni

D1

chains 175 and C175 with attachments
catene 175 e C175 con attacchi

APPLICATION
APPLICAZIONE **G**

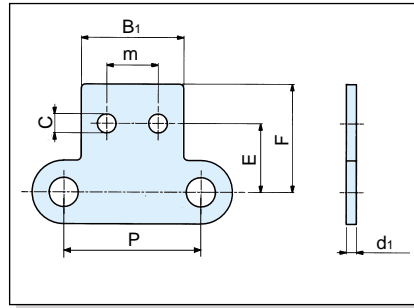
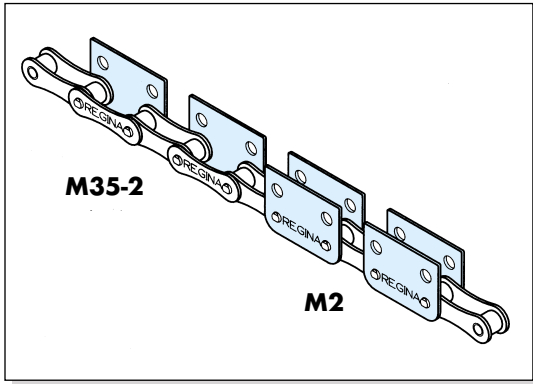

Roller link
Maglia interna

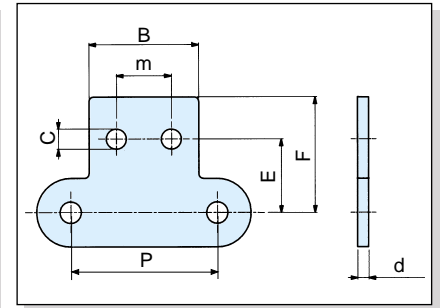

Pin link
Maglia esterna

ISO N°	Regina Chain N° Codice Catena Regina	Pitch Passo		Roller Diameter Diametro Rullo	Inside Width Larghezza interna	Attachment N° Codice Attacco	Attachment on roller link Attacco sulla maglia interna	Attachment on pin link Attacco sulla maglia esterna	Materials Materiali	Attachment dimensions Dimensioni attacchi							Add. weight per attachment Peso aggiuntivo per attacco	Availability Disponibilità
		P mm	" inches							Dr mm	W mm	B1 mm	B mm	C mm	d1 mm	d mm		

AMERICAN SERIES - SINGLE PITCH SERIE AMERICANA - PASSO SEMPLICE

10 A-1	A 50	15,875	5/8	10,16	9,40	M35-2 / M2	x	x	cs,ss	30,60	28,60	5,20	2,00	2,00	15,90	23,70	15,90	0,006	●
08 A-1	A 40	12,70	1/2	7,92	7,85	M35-2 / M2		x	cs	-	23,05	3,30	-	1,53	12,70	19,20	12,70	0,010	●
12 A-1	A 60	19,05	3/4	11,91	12,57	M35-2 / M2	x	x	cs,ss	-	34,90	5,60	2,30	2,30	18,25	31,85	19,00	0,015	●
16 A-1	A 80	25,40	1	15,88	15,75	M35-2 / M2		x	cs	-	45,85	6,80	-	3,10	24,60	36,75	25,40	0,029	●
20 A-1	A 100	31,75	1 1/4	19,05	18,90	137		x	cs	-	47,00	8,20	-	3,80	33,00	44,00	22,00	0,049	●
24 A-1	A 120	38,10	1 1/2	22,23	25,22	141		x	cs	-	73,00	10,30	-	4,80	40,00	55,00	38,10	0,124	○
28 A-1	A 140	44,45	1 3/4	25,40	25,22	149		x	cs	-	82,00	11,50	-	5,45	44,50	61,50	44,50	0,144	○
32 A-1	A 160	50,80	2	28,58	31,55	144		x	cs	-	93,00	13,10	-	6,15	50,80	74,00	50,00	0,256	○

EUROPEAN SERIES - DOUBLE PITCH SERIE EUROPEA - PASSO DOPPIO

208 B	2126	25,40	1	8,51	7,75	M35-2, M2		x	cs,ss	-	38,10	5,53	-	1,40	13,35	21,20	25,40	0,007	●
208 B	2126	25,40	1	8,51	7,75	153		x	cs	-	38,10	4,50	-	1,40	14,10	21,20	12,70	0,0101	●

AMERICAN SERIES - STRAIGHT SIDEPLATES - DOUBLE PITCH SERIE AMERICANA - PIASTRE DIRITTE - PASSO DOPPIO

C208AS	C2040	25,40	1	7,95	7,85	M35-2, M2	x	x	cs,ss	19,00	19,00	3,20	1,53	1,53	13,50	19,50	9,50	0,003	●
C210AS	C2050	31,75	1 1/4	10,16	9,40	M35-2, M2	x	x	cs,ss	11,90	11,90	5,20	2,00	2,00	15,90	24,60	25,40	0,006	●
C212A-H	C2060H	38,10	1 1/2	11,91	12,57	M35-2, M2	x		cs	28,00		5,60	3,25		19,05	30,00	14,30	0,011	●
C212A-H	C2060H	38,10	1 1/2	11,91	12,57	M35-2, M2		x	cs,ss		28,00	5,60		3,25	19,05	30,00	14,30	0,011	●
C216A-H	C2080H	50,80	2	15,88	15,75	154		x	cs	-	74,00	8,00	-	4,00	22,20	31,00	50,80	0,045	○
C216A-H	C2080H	50,80	2	15,88	15,75	177	x		cs	37,85	-	6,88	3,80	-	25,40	31,75	19,00	0,021	○
C216A-H	C2080H	50,80	2	15,88	15,75	178		x	cs	-	37,85	6,88	3,80	-	25,40	31,75	19,00	0,021	○
C216A-H	C2080H	50,80	2	15,88	15,75	171A	x		ss	38,00	-	6,88	3,80	-	25,40	31,75	19,00	0,022	○
C216A-H	C2080H	50,80	2	15,88	15,75	172A		x	ss	-	38,00	6,88	-	3,80	25,40	31,75	19,00	0,021	○
C216A-H	C2080H	50,80	2	15,88	15,75	M35-2, M2	x	x	cs	38,00		6,80	3,80	3,80	25,40	39,70	19,00	0,030	●
C220A-H	C2100H	63,50	2 1/2	19,05	18,90	M35-2, M2	x	x	cs	47,50	47,50	8,80	4,80	4,80	31,75	50,00	23,80	0,058	●
C224A-H	C2120H	76,20	3	22,23	25,22	M35-2, M2	x	x	cs	57,00	57,00	11,00	5,45	5,45	37,30	58,90	28,60	0,092	○

ROLLER CHAINS WITH A1 \ K1 TYPE ATTACHMENTS

CATENE A RULLI CON ATTACCHI TIPO A1 \ K1

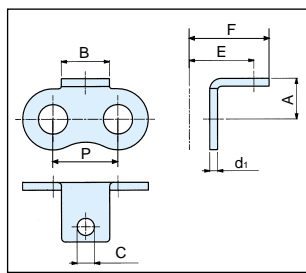
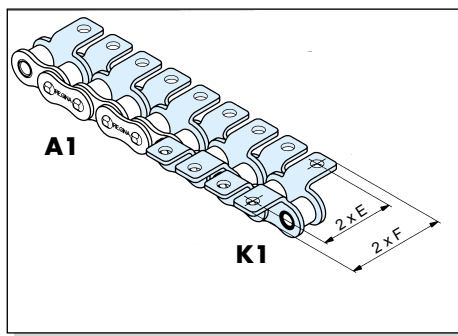

Roller link
Maglia interna

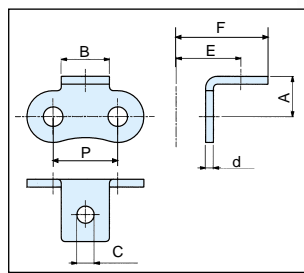

Pin link
Maglia esterna

APPLICATION
APPLICAZIONE **G**



ISO N°	Regina Chain N° Codice Catena Regina	Pitch Passo		Roller Diameter Diametro Rullo	Inside Width Larghezza interna	Attachment N° Codice Attacco	Attachment on roller link Attacco sulla maglia interna	Attachment on pin link Attacco sulla maglia esterna	Materials Materiali	Attachment dimensions Dimensioni attacchi						Add. weight per attachment Peso aggiuntivo per attacco	Availability Disponibilità	
		P mm	" inches							Dr mm	W mm	A mm	B mm	C mm	d1 mm			d mm
EUROPEAN SERIES - SINGLE PITCH SERIE EUROPEA - PASSO SEMPLICE																		
06B-1	C121	9,525	3/8	6,35	5,72	A1 / K1	x	x	cs,ss	6,50	8,00	3,50	1,27	1,03	9,50	13,50	0,001	●
06B-1	C121	9,525	3/8	6,35	5,72	143		x	cs	8,00	9,00	3,50	-	1,03	15,05 (16)	21 (22)	0,002	●
06B-1	C121	9,525	3/8	6,35	5,72	146	x		cs	8,00	9,00	4,10	1,27	-	15,33 (16)	20,33 (21)	0,002	○
06B-1	C121	9,525	3/8	6,35	5,72	1012A	x		ss	6,50	8,00	2,80	1,27	-	9,43	13,43	0,002	○
06B-1	C121	9,525	3/8	6,35	5,72	1015A		x	ss	6,50	8,00	2,80	-	1,03	9,18	13,18	0,002	○
082	50	12,70	1/2	7,75	2,38	146	x		cs	7,00	10,50	4,10	-	0,92	8,75	15,25	0,001	●
083	54	12,70	1/2	7,75	4,88	136		x	cs	7,20	9,50	3,50	-	1,40	9,39 (9,70)	16,19 (16,5)	0,001	●
083	54	12,70	1/2	7,75	4,88	A1 / K1	x	x	cs,ss	7,20	9,50	4,30	1,40	1,40	11,80	16,50	0,002	●
08B-1	126	12,70	1/2	8,51	7,75	170	x		cs	8,40	9,50	5,00	1,63	-	12,38	18,50	0,005	○
08B-1	126	12,70	1/2	8,51	7,75	171		x	cs	8,40	9,50	5,00	-	1,40	12,36	16,86	0,002	●
08B-1	126	12,70	1/2	8,51	7,75	A1 / K1	x	x	cs,ss	8,40	9,50	4,30	1,63	1,40	14,10	18,60	0,002	●
08B-1	8126	12,70	1/2	8,51	7,75	A1 / K1		x	cs	8,90	9,50	4,3/5,5	-	1,40	39,60	28,20	0,003	●
10B-1	136	15,875	5/8	10,16	9,65	151		x	cs	10,30	14,10	5,20	-	1,53	16,31 (16,65)	23,01	0,003	○
10B-1	136	15,875	5/8	10,16	9,65	193		x	cs	11,45	17,50	6,50	-	1,53	14,96 (15,30)	23,66	0,007	○
10B-1	136	15,875	5/8	10,16	9,65	163A		x	ss	10,30	14,10	6,80	-	1,53	14,96 (15,30)	23,01	0,003	○
10B-1	136	15,875	5/8	10,16	9,65	A1 / K1	x	x	cs,ss	10,40	14,10	5,20	1,63	1,53	15,90	23,80	0,003	●
10B-1	8136	15,875	5/8	10,16	9,65	A1 / K1		x	cs	10,30	14,10	5,3/7,55	-	1,53	33,60	50,00	0,006	○
12B-1	140	19,05	3/4	12,07	11,68	146		x	cs	9,70	28,00	6,10	-	1,80	20,09	30,19 (35,2)	0,010	○
12B-1	140	19,05	3/4	12,07	11,68	1030		x	cs	12,00	15,85	6,40	-	1,90	17,19 (17,5)	25,49 (25,80)	0,005	●
12B-1	140	19,05	3/4	12,07	11,68	1051A		x	ss	12,00	18,00	6,20	-	1,80	17,09 (17,6)	26,89 (31,9)	0,005	●
12B-1	140	19,05	3/4	12,07	11,68	A1 / K1	x	x	cs,ss	12,00	16,00	5,60	1,90	1,90	17,50	25,80	0,005	●
12B-1	8140	19,05	3/4	12,07	11,68	A1 / K1		x	cs	13,45	15,85	6,4/7,75	-	1,90	38,10	52,20	0,010	●
16B-1	147	25,40	1	15,88	17,02	166	x		cs	15,90	18,85	M6	3,80	-	25,40	37,40	0,014	●
16B-1	147	25,40	1	15,88	17,02	167		x	cs	15,90	18,85	M6	-	3,10	25,40	37,40	0,014	●
16B-1	147	25,40	1	15,88	17,02	178		x	cs	28,10	25,40	6,20	-	3,10	32,51 (33,1)	45,51 (46,1)	0,022	●
16B-1	147	25,40	1	15,88	17,02	A1 / K1	x	x	cs,ss	15,90	19,00	6,80	3,80	3,00	25,40	37,40	0,014	●
20B-1	152	31,75	1 1/4	19,05	19,56	140		x	cs	19,85	25,25	8,80	-	3,35	32,50	42,75	0,020	●
20B-1	152	31,75	1 1/4	19,05	19,56	144		x	cs	22,00	45,00	10,20	-	4,15	32,90	45,40	0,054	○
20B-1	152	31,75	1 1/4	19,05	19,56	148		x	cs	21,00	30,00	10,50	-	4,15	34,40	49,25	0,043	○
20B-1	152	31,75	1 1/4	19,05	19,56	158		x	cs	19,85	25,25	10,50	-	3,35	31,65	42,75	0,018	○
20B-1	152	31,75	1 1/4	19,05	19,56	170		x	cs	19,85	25,25	8,50	-	3,35	32,20	42,75	0,020	○
20B-1	152	31,75	1 1/4	19,05	19,56	A1 / K1	x	x	cs	19,85	25,25	8,40	-	3,35	31,75	42,85	0,020	●
24 B-1	157	38,10	1 1/2	25,40	25,40	139		x	cs	28,00	38,50	10,50	-	4,60	43,30	61,10	0,075	○
24 B-1	157	38,10	1 1/2	25,40	25,40	A1 / K1	x	x	cs	26,70	28,00	11,00	6,15	4,60	38,10	51,85	0,047	○
32 B-1	165	50,80	2	34,30	34,30	139		x	cs	46,50	35,00	7,00	-	6,15	52,25	66,20	0,096	○

AMERICAN SERIES - SINGLE PITCH SERIE AMERICANA - PASSO SEMPLICE																		
06C-1	A35	9,525	3/8	5,08	4,77	A1 / K1	x	x	cs,ss	6,30	7,90	2,28	1,27	1,27	9,50	13,50	0,001	●
08A-1	A40	12,70	1/2	7,95	7,85	A1 / K1	x	x	cs,ss	7,90	9,50	3,30	1,53	1,53	12,70	17,70	0,001	●
10A-1	A50	15,875	5/8	10,16	9,40	A1 / K1	x	x	cs,ss	10,30	14,10	5,20	2,00	2,00	15,90	23,80	0,004	●
12A-1	A60	19,05	3/4	11,91	12,57	A1 / K1	x	x	cs,ss	11,90	15,85	5,60	2,30	2,30	19,00	27,35	0,006	●
16A-1	A80	25,40	1	15,88	15,75	A1 / K1	x	x	cs,ss	15,90	18,85	6,80	3,10	3,10	25,40	34,80	0,012	●
20 A-1	A100	31,75	1 1/4	19,05	18,90	144		x	cs	19,85	25,40	6,50	-	3,80	33,40	41,80	0,028	○
20A-1	A100	31,75	1 1/4	19,05	18,90	A1 / K1	x	x	cs,ss	19,85	22,25	8,80	3,80	3,80	31,75	42,20	0,024	●
24A-1	A120	38,10	1 1/2	22,23	25,22	143		x	cs	23,00	28,60	8,80	-	4,80	38,00	52,40	0,059	○
24A-1	A120	38,10	1 1/2	22,23	25,22	A1 / K1	x	x	cs	23,00	28,45	11,00	4,60	4,60	38,10	52,40	0,038	○
28A-1	A140	44,45	1 3/4	25,40	25,22	A1 / K1	x	x	cs,ss	28,60	34,85	11,50	5,45	5,45	44,50	60,60	0,067	○
32A-1	A160	50,80	2	28,58	31,55	A1 / K1	x	x	cs	31,80	37,85	13,10	6,15	6,15	50,80	70,50	0,095	○

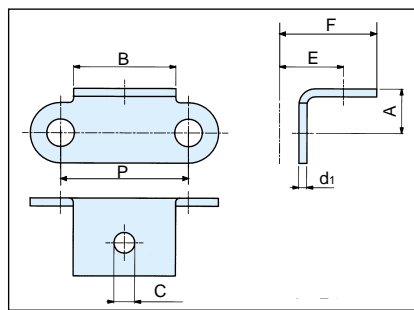
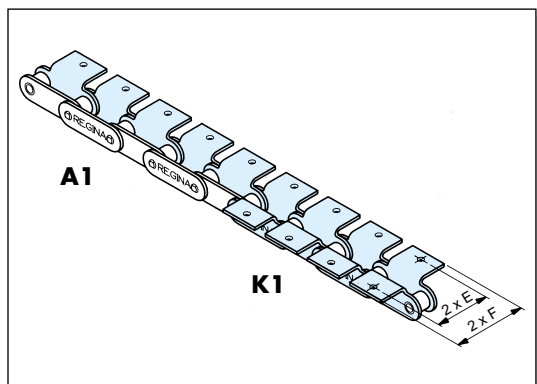

Roller link
Maglia interna

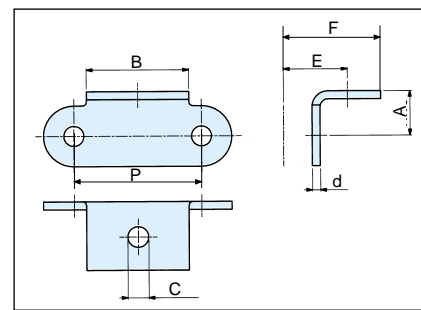

Pin link
Maglia esterna

ISO N°	Regina Chain N° Codice Catena Regina	Pitch Passo		Roller Diameter Diametro Rullo Dr	Inside Width Larghezza interna W	Attachment N° Codice Attacco	Attachment on roller link Attacco sulla maglia interna	Attachment on pin link Attacco sulla maglia esterna	Materials Materiali	Attachment dimensions Dimensioni attacchi						Add. weight per attachment Peso aggiuntivo per attacco kg	Availability Disponibilità
		P	" inches							A	B	C	d1	d	E		

EUROPEAN SERIES - DOUBLE PITCH SERIE EUROPEA - PASSO DOPPIO

208 B	2126	25,40	1,00	8,51	7,75	A1,K1	x		cs,ss	8,90	19,00	4,30	1,63		14,05	18,60	0,003	●
208 B	2126	25,40	1,00	8,51	7,75	A1,K1		x	cs,ss	8,90	19,00	4,30		1,40	14,05	18,60	0,003	○
210 B	2136	31,75	1,25	10,16	9,65	139	x		cs	7,75	18,00	5,00	1,63		11,48	19,98	0,003	○
210 B	2136	31,75	1,25	10,16	9,65	140		x	cs	7,75	18,00	5,00		1,63	15,06	23,46	0,003	●
210 B	2136	31,75	1,25	10,16	9,65	141	x		cs	7,75	18,00	4,00	1,63		14,28	21,78	0,004	●
210 B	2136	31,75	1,25	10,16	9,65	142		x	cs	7,75	18,00	4,00		1,63	14,28	21,78	0,004	●
210 B	2136	31,75	1,25	10,16	9,65	A1,K1	x		cs,ss	7,75	18,00	5,00	1,63		29,00	38,00	0,007	●
210 B	2136	31,75	1,25	10,16	9,65	A1,K1		x	cs,ss	7,75	18,00	5,00		1,53	29,00	38,00	0,007	●

AMERICAN SERIES - DOUBLE PITCH SERIE AMERICANA - PASSO DOPPIO

C208AS	C2040	25,40	1	7,95	7,85	A1,K1	x	x	cs,ss	11,10	19,00	3,20	1,53	1,53	12,70	19,10	0,004	●
C210AS	C2050	31,75	1 1/4	10,16	9,40	136	x		cs	2,55	10,30	5,15	2,00		23,35	30,15	0,001	○
C210AS	C2050	31,75	1 1/4	10,16	9,40	137		x	cs	2,55	10,30	5,15		2,00	23,35	30,15	0,001	○
C210AS	C2050	31,75	1 1/4	10,16	9,40	A1,K1	x	x	cs,ss	11,10	25,40	5,20	2,00	2,00	15,90	24,20	0,007	●
C210A-H	C2050H	31,75	1 1/4	10,16	9,40	159		x	cs	11,10	25,40	5,20		2,40	15,90	24,20	0,01	●
C212A-H	C2060H	38,10	1 1/2	11,91	12,57	A1,K1	x	x	cs,ss	14,70	28,00	5,60	3,25	3,25	21,40	30,20	0,011	●
C216A-H	C2080H	50,80	2	15,88	15,75	156		x	cs	19,00	38,00	M8	-	4,00	27,80	39,30	0,031	○
C216A-H	C2080H	50,80	2	15,88	15,75	157		x	cs	13,80	38,00	8,80	-	3,80	27,80	45,00	0,031	○
C216A-H	C2080H	50,80	2	15,88	15,75	A1,K1	x	x	cs	19,00	38,00	6,80	3,80	3,80	27,80	39,30	0,031	●
C220A-H	C2100H	63,50	2 1/2	19,05	18,90	151		x	cs	23,40	47,35	13,00	-	4,60	33,30	49,20	0,057	○
C220A-H	C2100H	63,50	2 1/2	19,05	18,90	A1,K1	x	x	cs	23,40	47,50	8,80	4,80	4,80	33,30	49,20	0,058	○
C224A-H	C2120H	76,20	3	22,23	25,22	A1,K1	x	x	cs	27,80	57,00	11,00	5,45	5,45	39,70	59,20	0,096	●

ROLLER CHAINS WITH A2 \ K2 TYPE ATTACHMENTS

CATENE A RULLI CON ATTACCHI TIPO A2 \ K2

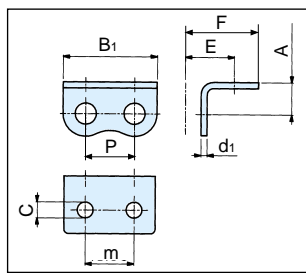
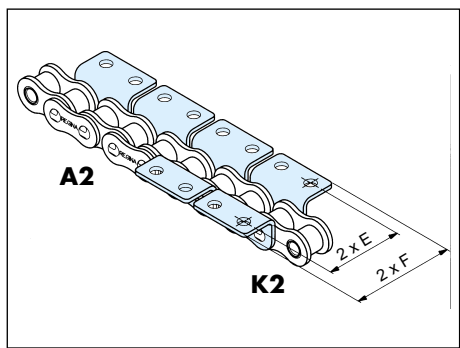

Roller link
Maglia interna

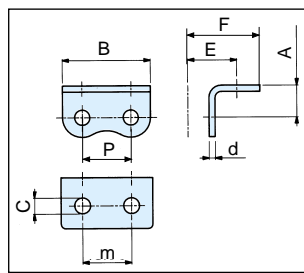

Pin link
Maglia esterna



APPLICATION APPLICAZIONE **G, D1**

ISO N°	Regina Chain N° Codice Catena Regina	Pitch Passo		Roller Diameter Diametro Rullo	Inside Width Larghezza interna	Attachment N° Codice Attacco	Attachment on roller link Attacco sulla maglia interna	Attachment on pin link Attacco sulla maglia esterna	Materials Materiali	Attachment dimensions Dimensioni attacchi								Add. weight per attachment Peso aggiuntivo per attacco	Availability Disponibilità
		P mm	" inches							Dr mm	W mm	A mm	B1 mm	B mm	C mm	d1 mm	d mm		

EUROPEAN SERIES - SINGLE PITCH SERIE EUROPEA - PASSO SEMPLICE

06B-1	C121	9,53	3/8	6,35	5,72	A2 / K2		x	cs	6,50	-	17,55	3,50	-	1,03	9,50	13,50	9,50	0,001	●
08B-1	126	12,70	1/2	8,51	7,75	172A		x	ss	10,00		23,20	4,50		1,40	11,70	19,05	12,70	0,003	●
08B-1	126	12,70	1/2	8,51	7,75	A2 / K2	x	x	cs,ss	8,40	24,45	23,05	4,30	1,63	1,40	14,10	18,60	12,70	0,004	●
08B-1	8126	12,70	1/2	8,51	7,75	A2 / K2		x	cs	8,40		23,05	4,3/5,55		1,40	14,10	18,60	12,70	0,005	●
10B-1	136	15,875	5/8	10,16	9,65	140		x	cs	12,00		29,80	4,25		1,53	17,65	27,30	15,88	0,090	○
10B-1	136	15,875	5/8	10,16	9,65	A2 / K2	x	x	cs,ss	10,30	30,00	28,60	5,20	1,63	1,53	15,90	23,80	15,90	0,006	●
10B-1	8136	15,875	5/8	10,16	9,65	A2 / K2		x	cs	10,30		28,60	5,2/7,55		1,53	15,90	23,80	15,90	0,009	●
12B-1	140	19,05	3/4	12,07	11,68	A2 / K2	x	x	cs,ss	12,00	35,00	34,90	5,60	1,90	1,90	17,50	31,40	19,00	0,012	●
12B-1	140	19,05	3/4	12,07	11,68	A2 / K2		x	cs,ss	12,00		34,90	6,4/7,75		1,90	17,50	31,40	19,00	0,018	●
16B-1	147	25,40	1	15,88	17,02	140		x	cs	15,90		46,00	10,35 (M6)		3,10	25,40	39,700	25,40	0,03	●
16B-1	147	25,40	1	15,88	17,02	A2 / K2	x	x	cs,ss	15,90	46,00	45,85	6,80	3,80	3,00	25,40	39,70	25,40	0,035	●
20B-1	152	31,75	1 1/4	19,05	19,56	143		x	cs	20,00		46,00	8,50		4,15	34,90	44,40	31,75	0,050	○
24B-1	157	38,10	1 1/2	25,40	25,40	156		x	cs	28,00		71,35	10,50		4,60	43,50	57,00	38,10	0,109	○
40B-1	175	63,50	2 1/2	39,37	38,10	138		x	cs	35,00		115,00	15,00		8,00	59,85	77,25	80,00	0,430	●
40B-1	175	63,50	2 1/2	39,37	38,10	149		x	cs	39,00		115,00	17,00		8,00	59,85	78,25	80,00	0,410	○
40B-1	175	63,50	2 1/2	39,37	38,10	152		x	cs	35,00		115,00	15,00		8,00	59,85	77,25	80,00	0,383	○
48B-1	181	76,20	3	48,26	45,72	138		x	cs	45,00		140,00	16,20		9,50	75,00	103,60	85,00	0,745	○
48B-1	181	76,20	3	48,26	45,72	A2 / K2		x	cs	45,00		140,00	17,00		9,50	75,00	103,60	85,00	0,742	○

AMERICAN SERIES - SINGLE PITCH SERIE AMERICANA - PASSO SEMPLICE

10A-1	A50	15,88	5/8	10,16	9,40	A2 / K2	x	x	cs,ss	10,30	30,60	28,60	5,20	2,00	2,00	15,90	23,80	15,90	0,006	●
12A-1	A60	19,05	3/4	11,91	12,57	A2 / K2		x	cs	11,90		34,90	5,60		2,30	19,00	31,60	19,00	0,015	●
20 A-1	A 100	31,75	1 1/4	19,05	18,90	155		x	cs	19,85		47,00	9,50		3,80	34,30	44,20	22,00	0,043	○
20 A-1	A 100	31,75	1 1/4	19,05	18,90	157		x	cs	19,85		47,00	8,20		3,80	31,75	45,00	28,60	0,045	○
-	A100H OR	31,75	1 1/4	19,05	18,90	136 ZC		x	cs	21,00		57,00	10,50		4,60	36,60	50,50	31,75	0,069	○
24 A-1	A 120	38,10	1 1/2	22,23	25,22	146		x	cs	25,50		73,00	10,30		4,80	40,60	54,70	38,00	0,117	●
28 A-1	A 140	44,45	1 3/4	25,40	25,22	136		x	cs	25,00		82,50	10,40		5,45	34,70	49,20	42,00	0,119	●
28 A-1	A 140	44,45	1 3/4	25,40	25,22	151	x		cs	28,60	82,00		10,50	5,45	-	50,40	60,40	44,50	0,147	●
32 A-1	A 160	50,80	2	28,58	31,55	150		x	cs	31,80		93,00	11,00		6,15	44,60	59,60	50,00	0,189	○
40 A-1	A 200	63,50	2 1/2	39,68	37,85	142		x	cs	35,00		115,00	13,00		8,00	59,40	76,60	80,00	0,352	●

Typical applications
Applicazioni comuni

D1

chains 175 and A200 with attachments
catene 175 e A200 con attacchi

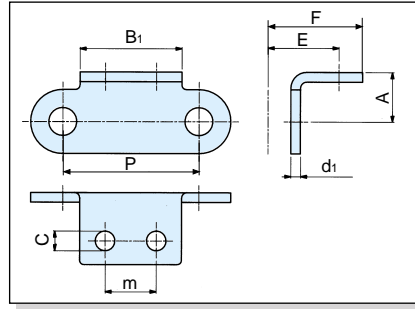
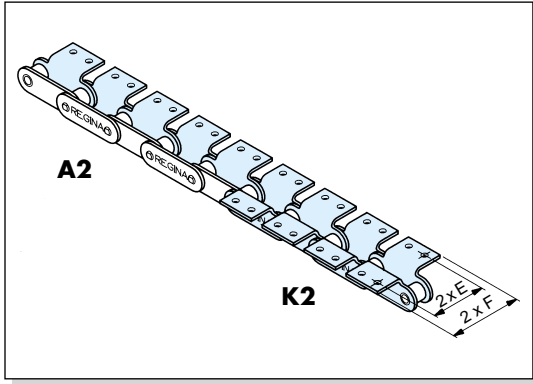

Roller link
Maglia interna

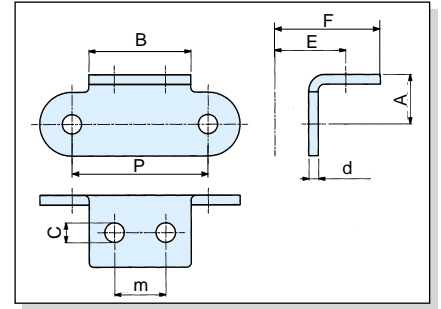

Pin link
Maglia esterna

APPLICATION
APPLICAZIONE **G**

ISO N°	Regina Chain N° Codice Catena Regina	Pitch Passo	Roller Diameter Diametro Rullo	Inside Width Larghezza interna	Attachment N° Codice Attacco	Attachment on roller link Attacco sulla maglia interna	Attachment on pin link Attacco sulla maglia esterna	Materials Materiali	Attachment dimensions Dimensioni attacchi							Add. weight per attachment Peso aggiuntivo per attacco	Availability Disponibilità
									P mm " inches	Dr mm	W mm	A mm	B1 mm	B mm	C mm		

EUROPEAN SERIES - DOUBLE PITCH SERIE EUROPEA - PASSO DOPPIO

208 B	2126	25,40	1	8,51	7,75	A2 / K2	x	x	cs,ss	8,90	38,10	38,10	5,53	1,63	1,40	12,70	20,60	25,40	0,008	●
-------	------	-------	---	------	------	---------	---	---	-------	------	-------	-------	------	------	------	-------	-------	-------	-------	---

AMERICAN SERIES - STRAIGHT SIDEPLATES - DOUBLE PITCH SERIE AMERICANA - PIASTRE DIRITTE - PASSO DOPPIO

C208AS	C2040	25,40	1	7,95	7,85	A2 / K2	x	x	cs,ss	9,10	19,00	19,00	3,20	1,53	1,53	12,70	19,10	9,50	0,003	●
C210AS	C2050	31,75	1 1/4	10,16	9,40	A2 / K2	x	x	cs,ss	11,10	25,40	25,40	5,20	2,00	2,00	15,90	24,20	11,90	0,007	●
C212AH	C2060H	38,10	1 1/2	11,91	12,57	A2 / K2	x	x	cs,ss	14,70	28,00	28,00	5,60	3,25	3,25	21,40	30,20	14,30	0,011	●
C216AH	C2080H	50,80	2	15,88	15,75	148		x	cs	19,00	-	38,00	6,40	-	4,00	27,80	39,30	19,00	0,037	○
C216AH	C2080H	50,80	2	15,88	15,75	149	x		ss	18,25	38,00	-	6,88	4,00	-	27,80	35,70	19,00	0,029	○
C216AH	C2080H	50,80	2	15,88	15,75	152		x	cs	19,00	-	38,00	8,00	-	4,00	27,80	39,30	19,00	0,029	○
C216AH	C2080H	50,80	2	15,88	15,75	123A	x		ss	18,25	38,00	-	6,88	4,00	-	25,40	35,70	19,00	0,031	○
C216AH	C2080H	50,80	2	15,88	15,75	124A		x	ss	18,25	-	38,00	6,88	-	4,00	25,40	40,00	19,00	0,031	○
C216AH	C2080H	50,80	2	15,88	15,75	A2 / K2	x	x	cs	19,00	38,00	38,00	6,80	3,80	3,80	27,80	39,30	19,00	0,03	●
C220AH	C2100H	63,50	2 1/2	19,05	18,90	146		x	cs	23,40	-	47,50	8,80	-	4,60	33,30	49,20	23,80	0,054	○
C220AH	C2100H	63,50	2 1/2	19,05	18,90	A2 / K2	x		cs	23,40	47,50	-	8,80	4,80	-	33,30	49,20	23,80	0,058	●
C220AH	C2100H	63,50	2 1/2	19,05	18,90	A2 / K2		x	cs,ss	23,40	-	47,50	8,80	-	4,80	33,30	49,20	23,80	0,058	●
C224AH	C2120H	76,20	3	22,23	25,22	136		x	cs	32,80	-	57,00	11,00	-	5,65	39,70	54,20	28,80	0,088	○
C224AH	C2120H	76,20	3	22,23	25,22	137	x		cs	27,80	57,00	-	7,00	5,65	-	33,00	40,00	40,00	0,088	○
C224AH	C2120H	76,20	3	22,23	25,22	138		x	cs	32,80	-	57,00	7,00	-	5,45	36,90	54,20	28,80	0,069	○
C224AH	C2120H	76,20	3	22,23	25,22	139	x		cs	27,80	40,00	-	9/7	-	5,65	33,00	40,00	40,00	0,087	●
C224AH	C2120H	76,20	3	22,23	25,22	140		x	cs	32,00	-	57,00	6,50	-	5,45	38,20	45,80	23,80	0,095	●
C224AH	C2120H	76,20	3	22,23	25,22	147A		x	ss	27,80	-	57,00	10,50	-	5,50	39,70	59,20	28,60	0,093	○
C224AH	C2120H	76,20	3	22,23	25,22	A2 / K2	x	x	cs	27,80	57,00	57,00	11,00	5,45	5,45	39,70	59,20	28,60	0,092	●

Any questions? Please contact us.

Morskate Aandrijvingen BV
Oosterveldsingel 47A
7558 PJ Hengelo (Ov)
The Netherlands

NL
T +31 (0)74 - 760 11 11
info@morskateaandrijvingen.nl
www.morskateaandrijvingen.nl

DE
T +49 692 - 222 34 95
info@morskateantriebstechnik.de
www.morskateantriebstechnik.de

EN
T +31 (0)74 - 760 11 11
info@morskatedrivetechnology.com
www.morskatedrivetechnology.com